

GSA 27F-5066-C APPROVED



THE LEADING EDGE IN MODULAR ERGONOMICS

ALL MODELS ON THE COVER SHIP IN 5 DAYS OR LESS!



THE "MODEL HD"



ERGO-LINE

Quality Ergonomics at a Price Any Company Can Afford. Professional Independent Workstations. ESD, Clean Room or to Your Own Design. **BEST VALUE! IN STOCK**

"State-of-the-Art" Ergonomic Hand Crank Vertical and/or Tilt Adjust. Reduce Repetitive Motion Stress and Increase Productivity. "The Workstation for the next century" **IN STOCK**



THE BASICS
NEW TO THE IN STOCK PROGRAM

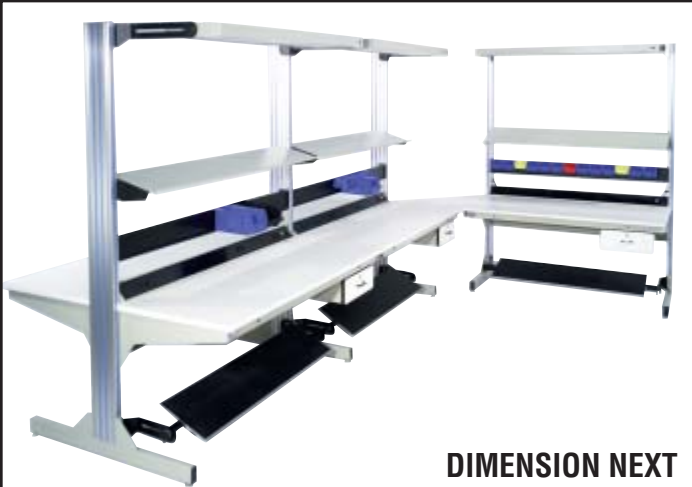

DIMENSION NEXT

The Basics Workbench
Incorporates an open frame concept
Available single and double sided. **IN STOCK**

MODULAR TECHNICAL SYSTEMS
Free Standing and Add on Units
Single and Double Sided. **IN STOCK**



IN STOCK

Frame
 In Stock Colors:
 Light Blue, Light Gray and Light Beige
 Work Surface: White
 with Black
 "T" Mold Edges
 HD, CHD, EL



Model MVSII

MVSII In Stock in Light Blue

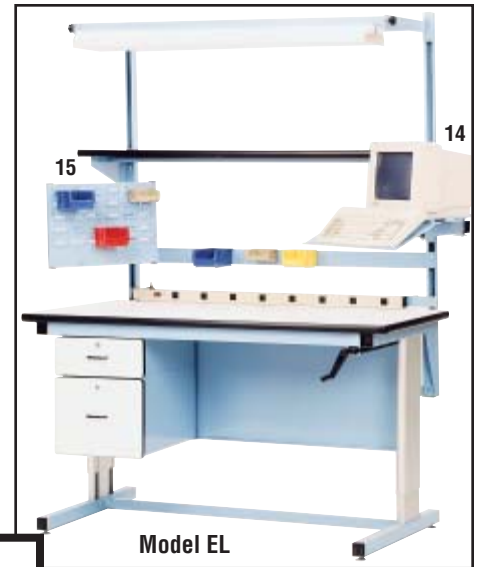

Model EL

Beige, Blue, Gray



The BASICS

See page 17 for details

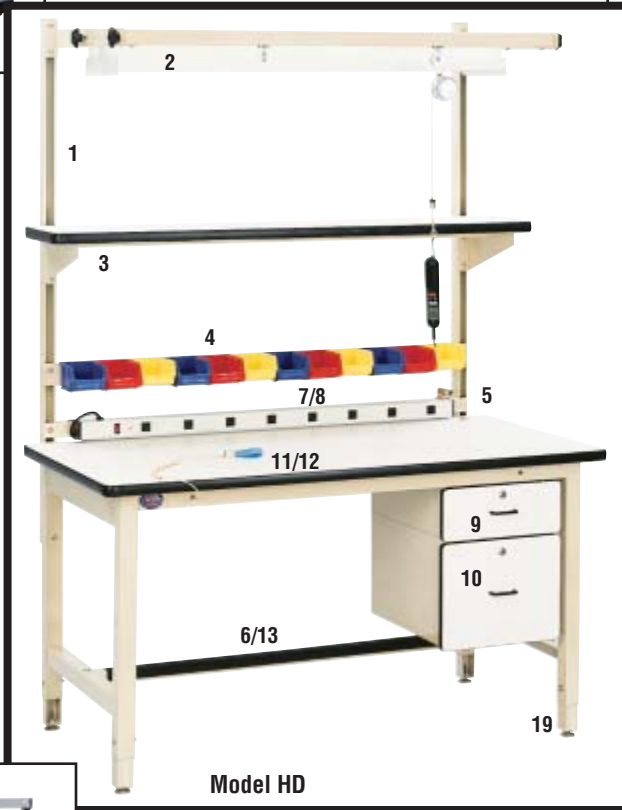

Model HD

Beige, Blue, Gray



Model CHD

Beige, Blue, Gray



Model CPB

CPB Light Gray Only



Model HD with Riser Shelf

Risers and Padlock Drawer In Stock in Light Blue

IN STOCK QUICK SHIP PROGRAM

Pro-Line in stock products ship in 5 business days or less.
 Pro-Line guarantees 10 pieces per model and color will be in stock.
 For quantities larger than 10 call factory for availability.

Light Blue Only (Model MVSII)
Light Blue Only (Risers and Riser Options/DP-1)

Configure the work station to meet your requirements.
 When ordering please specify base model, (HD6030). Work surface choice: (P) standard laminate (ESD) ESD laminate (M) maple. Select options from graph below. Keep in mind some components mount to other components. ie: (OLF) light frame mounts to (UR60) uprights. Please specify frame color. Light Beige, Light Blue or Light Gray. Packaging Station available in Light Gray.

Base Models

Model HD 60" L x 30" W x 30" H		
STOCK NO.	TOP	Wgt. (lbs)
HD6030P	Plastic	115
HD6030C	Conductive	115
HD6030M	Maple	124
Model HD 60" L x 36" W x 30" H		
STOCK NO.	TOP	Wgt. (lbs)
HD6036P	Plastic	125
HD6036C	Conductive	125
HD6036M	Maple	162
Model CHD 60" L x 30" W x 30" H		
STOCK NO.	TOP	Wgt. (lbs)
CHD6030P	Plastic	138
CHD6030C	Conductive	138
CHD6030M	Maple	168
Model Ergoline 60" L x 30" W x 30" H to 42" H		
STOCK NO.	TOP	Wgt. (lbs)
EL6030P	Plastic	140
EL6030C	Conductive	140
EL6030M	Maple	175
Model MVSII 60" L x 30" W (Light Blue Only)		
STOCK NO.	TOP	Wgt. (lbs)
MVSII6030P	Plastic	210
MVSII6030C	Conductive	210
MVSII6030M	Maple	240

Model HD 72" L x 30" W x 30" H		
STOCK NO.	TOP	Wgt. (lbs)
HD7230P	Plastic	130
HD7230C	Conductive	130
HD7230M	Maple	145
Model HD 72" L x 36" W x 30" H		
STOCK NO.	TOP	Wgt. (lbs)
HD7236P	Plastic	140
HD7236C	Conductive	140
HD7236M	Maple	184
Model CHD 72" L x 30" W x 30" H		
STOCK NO.	TOP	Wgt. (lbs)
CHD7230P	Plastic	158
CHD7230C	Conductive	158
CHD7230M	Maple	195
Model Ergoline 72" L x 30" W x 30" H to 42" H		
STOCK NO.	TOP	Wgt. (lbs)
EL7230P	Plastic	155
EL7230C	Conductive	155
EL7230M	Maple	192
Model MVSII 72" L x 30" W (Light Blue Only)		
STOCK NO.	TOP	Wgt. (lbs)
MVSII7230P	Plastic	230
MVSII7230C	Conductive	230
MVSII7230M	Maple	272

Optional In Stock Modular Accessories For Quick Ship Stations

For 60" L x 30" W				Optional In Stock Modular Accessories For Quick Ship Stations	For 72" L x 30" W	
No.	Description	Stock #	Weight		Stock #	Weight
1	Accessory Upright Supports (one pair) Extend 48" above surface	UR60	20	UR60	20	
2	Overhead Light Frame with 2 bulb fixture	OLF60	27	OLF72	28	
3	12" Deep Cantilever Shelf	CSPL1260P	30	CSPL1272P	36	
3A	12" Deep Cantilever Shelf ESD	CSPL1260C	30	CSPL1272C	36	
3B	18" Deep Cantilever Shelf	CSPL1860P	35	CSPL1872P	40	
3C	18" Deep Cantilever Shelf ESD	CSPL1860C	35	CSPL1872C	40	
4	Bin Holder	BH60	6	BH72	7	
5	Air Supply (mounts ESMR)	AQDC	1.5	AQDC	1.5	
6	Footrest	FR60	7	FR72	8	
7	Power Supply (8 outlets 15 amp 120 volt)	ES48	4.5	ES48	4.5	
8	Electrical Supply Mounting Rail	ESMR60	6	ESMR72	7	
9	6" Drawer includes lock (Steel housing with laminate drawer face)	MDS6	26	MDS6	26	
10	12" Drawer includes lock (Steel housing with laminate drawer face)	MDS12	38	MDS12	38	
	Drawer Hanging Kit (one per station required with drawers, POWS or DP-1)	HK	0.52	HK	0.52	
11	Ground Kit for Conductive Stations includes two banana jacks	SGK-J2	0.5	SGK-J2	0.5	
12	Wrist Strap (requires SGK-J2)	SGS-4	0.25	SGS-4	0.25	
13	Footrest Guard	FRG60	0.5	FRG72	0.5	
14	Articulating Monitor Arm	MA-1	19	MA-1	19	
15	Articulating Bin Arm	ABH-1	19	ABH-1	19	
16	Tool Suspension Frame II (mounts to OLF)	LTF60	13	LTF72	14	
17	Tool Balancer (mounts to LTF)	TB-5	6	TB-5	6	
18	Pull Out Writing Shelf	POWS	12	POWS	12	
19	6" Leg Extenders (Model HD only) 6" adjustment	HDLE-6	8	HDLE-6	8	
20	3 Diopter Inspection Light	MAG1	9	MAG1	9	
21	Inspection Light Mounting Bracket	LOMB	1	LOMB	1	
22	Pad Lock Drawer (Light Blue Only)	DP-1	13	DP-1	13	
Optional In Stock Work Surfaces Up Charge						
23	90 degree rolled front edge upcharge	PF	N/A	PF	N/A	



IN STOCK QUICK SHIP PROGRAM (CONTINUED)

DIMENSION NEXT



MODULAR TECHNICAL SYSTEMS

'DIMENSION NEXT' EXPANDABLE MODULAR WORK STATIONS

Top quality finish meets modular ergonomic function with a price that is still affordable.

Solid slotted aluminum uprights allow work surface or optional accessories to be mounted anywhere along column. Heavy gauge steel frame bolts to top supports adding strength to the work surface and lateral support to the station. **Stock colors are textured beige powder coat finish with blue accents strips** offers a durable finish with superior esthetics. Stations are 82" overall height. Work surfaces and optional accessories adjust independently of each other on double sided stations. 1000 lbs. capacity.

- Single sided starter station includes two uprights, two horizontal leg supports, one top frame assembly and one 180 degree front edge work surface with standard or ESD laminate.

- Single sided add on station includes one upright, one horizontal leg support, one top frame assembly and one 180 degree front edge work surface with standard or ESD laminate.

- Double sided starter station includes two uprights, two back to back horizontal leg supports, two top frame assemblies and two 180 degree work surfaces with standard or ESD laminate.

- Double sided add on station includes one upright, one back to back horizontal leg support, two top frame assemblies and two 180 degree front edge work surfaces with standard or ESD laminate.

(each row requires one starter unit)

In Stock 60" & 72" Long



**Available in
Powder Coat
Textured
Finish Only**

Textured color options shown on page 52

Base Part NO./ Size	Plastic Laminate	ESD Laminate
DN6030SS 60"L x 30"W Single Starter	DN6030SSPL Wgt. (lbs) 198	DN6030SSESD Wgt. (lbs) 198
DN7230SS 72"L x 30"W Single Starter	DN7230SSPL Wgt. (lbs) 217	DN7230SSESD Wgt. (lbs) 217
DN6030SA 60"L x 30"W Single Add-On	DN6030SAPL Wgt. (lbs) 148	DN6030SAESD Wgt. (lbs) 148
DN7230SA 72"L x 30"W Single Add-On	DN7230SAPL Wgt. (lbs) 168	DN7230SAESD Wgt. (lbs) 168

Base Part NO./ Size	Plastic Laminate	ESD Laminate
DN6030DS 60"L x 30"W Double Starter	DN6030DSPL Wgt. (lbs) 307	DN6030DSESD Wgt. (lbs) 307
DN7230DS 72"L x 30"W Double Starter	DN7230DSPL Wgt. (lbs) 360	DN7230DSESD Wgt. (lbs) 360
DN6030DA 60"L x 30"W Double Add-On	DN6030DAPL Wgt. (lbs) 260	DN6030DAESD Wgt. (lbs) 260
DN7230DA 72"L x 30"W Double Add-On	DN7230DAPL Wgt. (lbs) 300	DN7230DAESD Wgt. (lbs) 300





IN STOCK QUICK SHIP PROGRAM (CONTINUED)



OPTIONAL ACCESSORIES FOR THE DIMENSION NEXT

Dimension Next optional modular accessories allow you to configure your station to meet your needs. Easily adjustable in the field the Dimension Next options adjust anywhere along upright. Adjustments are made with handles included in the price of the options. No tools are required to make adjustments. All of the model DN options are painted with a textured powder coat finish for years of use.

PART NO.	DESCRIPTION	WGT. (LBS)
DNFR60	Height adjustable and pivoting footrest pan fits 60" long DN stations.	27
DNFR72	Height adjustable and pivoting footrest pan fits 72" long DN stations.	33
DNES60	Power supply with 8 outlets, lighted on/off switch, built in circuit breaker and 6' long cord. Fits 60" long DN stations.	16
DNES72	Power supply with 8 outlets, lighted on/off switch, built in circuit breaker and 6' long cord. Fits 72" long DN stations.	20
DNBH60	Bin Holder for a 60" long DN station.	13
DNBH72	Bin Holder for a 72" long DN station.	16
DNCCUP	Corner Unit for 30" deep model DN Standard Laminate	25
DNCCUC	Corner Unit for 30" deep model DN ESD Laminate	25

PART NO.	DESCRIPTION	WGT. (LBS)
DNOLF60	Over head light fixture and frame. Price includes dual bulb fixture with lighted on/off switch and a 9' long cord, for a 60" long DN station.	30
DNOLF72	Over head light fixture and frame. Price includes dual bulb fixture with lighted on/off switch and a 9' long cord, for a 72" long DN station.	32
DNAMS1260	Adjustable metal shelf 12" deep x 60" long.	32
DNAMS1272	Adjustable metal shelf 12" deep x 72" long.	39
MDS6	Modular Drawer 6" high x 15" wide x 19.25" long. Price includes lock. Features include roller bearing guide and white laminate drawer face with rounded corners.	26
MDS12	Modular Drawer 12" high x 15" wide x 19.25" long. Price includes lock. Features include roller bearing guide and white laminate drawer face with rounded corners.	38
HK	Drawer Hanging Kit (one required per station with drawers.)	1.15
SGK-J2	Standard Ground Kit with 2 banana jacks. (For ESD stations only.)	0.5



Standard 180° Rolled Edge



In Stock for Model DN



IN STOCK QUICK SHIP PROGRAM



Model CPB 60" L x 30" W x 30" to 36" H

PART NO.	TOP	Wgt. (lbs)
CPB6030P	Plastic	325
CPB6030C	Conductive	325
CPB6030M	Maple	362

Model CPB 72" L x 30" W x 30" to 36" H

PART NO.	TOP	Wgt. (lbs)
CPB7230P	Plastic	355
CPB7230C	Conductive	355
CPB7230M	Maple	399

PACKAGING STATION COMPLETE

Pro-Line's packaging stations are sold complete with all accessories shown. Features include lower metal shelf with four dividers, full storage shelf with 4" clearance, UR72 uprights, bin holder, 6 outlet electric supply, paper spool holder, enclosed metal shelf 12" deep with four dividers, corrugated storage shelf with four 12" x 18" dividers, and shop light. ESD price includes ground kit.



Packaging Stations are available in Light Gray Frame Only.

See page 20 for more Pack Stations

TECHNICIAN STATIONS

The **Model TSHD** comes complete as shown. Price includes base unit 30" or 36" deep and 60" or 72" long. (Work surface height adjusts from 30" to 36"), modular draw 6" and 12" with laminate face, personal pad lock drawer with hanging kits, riser 12" deep x 18" high with 6 pre-wired outlets, and a 90° rolled front edge. ESD stations also include ESD work surface and ESD shelf surface and a standard ground kit with two banana jacks.

THE MODEL TSHD

One great station,

one great price,

one easy to order part number.



The model TSHD is in stock with white surfaces and light blue frames.

BASE PART NO./ SIZE	Plastic Laminate	ESD Laminate
TSHD6030 60"L x 30"W	TSHD6030PL Wgt (lbs) 254	TSHD6030ESD Wgt (lbs) 255
TSHD7230 72"L x 30"W	TSHD7230PL Wgt (lbs) 278	TSHD7230ESD Wgt (lbs) 278
TSHD6036 60"L x 36"W	TSHD6036PL Wgt (lbs) 264	TSHD6036ESD Wgt (lbs) 265
TSHD7236 72"L x 36"W	TSHD7236PL Wgt (lbs) 288	TSHD7236ESD Wgt (lbs) 288

Front brace of riser removed to show electrical outlets.

Riser without Electric

DESCRIPTION/SIZE	Plastic Laminate	ESD Laminate
60"Lx12"Wx18"H	R6012-1PL	R6012-1ESD
	Wgt (lbs) 41	Wgt (lbs) 41
72"x12"Wx18"H	R7212-1PL	R7212-1ESD
	Wgt (lbs) 48	Wgt. (lbs) 48

Riser with 6 Electric Outlets (across rear)

DESCRIPTION/SIZE	Plastic Laminate	ESD Laminate
60"Lx12"Wx18"H	R6012-3PL	R6012-3ESD
	Wgt (lbs) 46	Wgt (lbs) 46
72"x12"Wx18"H	R7212-3PL	R7212-3ESD
	Wgt (lbs) 53	Wgt. (lbs) 53

See photograph inside front cover and pages 6, 8.

Riser Shelf Surfaces Standard or ESD Laminate with "T" Mold

Pro-Line's Riser shelves turn any of our stations into a Technical Work Station. Heavy gauge painted steel frame easily mounts to all of our models. The -3 includes 6 built-in 15 amp 120-volt electrical outlets across rear support. **Front brace of riser removed to show electrical outlets.**

In Stock in Light Blue only.

ADDITIONAL IN STOCK RISER OPTIONS

Optional enclosure panel for riser leg. Shown on inside front cover. In Light Blue QS Only

S-2	Enclosure Panel Wgt. (lbs) 2.5
------------	-----------------------------------

The 6RE is a pair of 6" riser extensions. Raises height of riser to 24" over all height.

6RE	Riser Extensions Wgt. (lbs) 12/pr
------------	--------------------------------------

The S-2EP electrical panel allows you to add additional outlets to either -1 or -2 riser shelves. Price includes panel with 6 outlets, on/off switch, built-in circuit breaker and power cord.

S-2EP	Electrical Panel Wgt. (lbs) 8
--------------	----------------------------------



6RE Riser Extensions



S-2EP Electrical Panel

TERMS AND CONDITIONS

Orders placed with the factory are due and payable net 30 days. The F.O.B. point is our factory in Haverhill, MA. The minimum order amount is \$25.00, and all cancelled standard orders are subject to a cancellation charge of up to 25% of the original order. In addition, all orders, standard or special, entered upon our books cannot be countermanded except with our consent, and then only upon terms that will indemnify us against loss.

Shipment

Pro-Line will ship your order either **KDF** (knock down freight) or **Assembled** based on customer preference. Please specify preference on your order. **(Orders are shipped KDF by default if no preference is specified).**

Damage in Transit

For your protection, examine each shipment carefully for external damage. If there is any evidence of damage or shortage in transit, insist that the delivery carrier make appropriate notation on the freight bill of lading before you sign anything. If, after receipt, any internal or hidden damage is discovered, immediately notify the carrier and request an inspection report to support your claim. Claims for damage or shortages in transit must be filed with the delivery carrier. Pro-Line will not accept any return of merchandise that has been damaged in transit. Your recourse is with the delivery carrier.

Returned Merchandise

No goods are to be returned to Pro-Line without a written R.G.A. (returned goods authorization). A handling fee of 25% or \$25.00, whichever is greater, will be charged on all returned merchandise.

Specifications

Pro-Line reserves the right to make changes at any time, without notice, in colors, prices, materials, equipment, specifications or models. Although every effort has been made to ensure the accuracy of all information contained in this catalog, Pro-Line cannot be held responsible for any omissions or typographical errors. Please check with your local Pro-Line representative or distributor, or contact the factory direct, for the latest and most complete information before ordering.

Pro-Line products are warranted to the original user to be free from defects in design, material and workmanship, given normal use and care, for a period of eleven (11) years of a single shift service, from the date of purchase.

With the exceptions noted below, Pro-Line, at its option, will repair or replace any products or part thereof which fails as a result of such a defect during the following warranty periods (prorated for multi shift operation).

All Pro-Line products (except as noted)	Eleven years
Operating components, functional mechanisms, high-wear parts such as casters	Five years
Wood or wood/metal framed products	Two years
Textiles, covering materials, foam, finishes, exposed wood, fabrics, laminated electrical components, and electric or hydraulic height adjustable bench components	One year

This warranty is limited to the replacement and/or repair only, of such defective part(s) authorized in writing to be returned to Pro-Line with transportation fees and costs prepaid by the purchaser, and provided that examination by Pro-Line discloses such defect(s). In no way shall Pro-Line be responsible for any damage by the carrier, abuse, negligence, misuse, user modifications, or customers material(s). Pro-Line does not warrant the matching of color, grain, or texture.

Accessories, components, parts, and laminates not manufactured by Pro-Line are warranted to the extent of the original manufacturer's warranty.

Pro-Line will not accept unauthorized fees or charges for expenses (i.e., labor and freight) incurred by the customer. Products which have been repaired or altered by anyone other than Pro-Line or without Pro-Line's written permission or, in our judgement, has been subject to misuse, neglect, accident, or use outside specifications by purchaser or others are excluded from this warranty.

This warranty is in lieu of any other expressed or implied warranty, including any implied of merchantability or fitness for a particular purpose, and of any other obligations or liability on the part of Pro-Line.

Visit us on the web at Web Site www.1proline.com
or email us at bench@1proline.com

INTRODUCTION

A FOCUS ON ERGONOMICS

Next to the common cold, no problem accounts for more lost work days (or as many doctor visits) as the aching back. The majority of workplace back injuries result from small, repeated doses of damage rather than from a single specific incident. According to OSHA, each year back injuries account for 28.6 lost workdays per 100 workers. Bureau of Labor Statistics data show that lost workdays from all injuries has increased from 62.1 days per 100 workers in 1978 to 74.2 workdays in 1989. The Department of Health and Human Services had hoped to reduce lost workdays to 35 per 100 by 1990, a goal that has become utterly hopeless in the face of rising rates of muscular-skeletal injuries. Cumulative trauma disorders (CTD's) are the most rapidly growing category of injuries and illnesses reported to OSHA. In 1980 only 18% of work-related illness could be laid at the doorstep of "ergonomic disorders"; by 1990, that figure had risen to 55%. Other studies have indicated the lost days were even higher than claimed by the Bureau of Labor Statistics.

Lost work days and hours are only part of the problem. Workers trying to make their body fit the task rather than the task fit the body are losing productivity due to fatigue every hour they are "on" the job. Measuring hours lost on the job is far more difficult.

The first line of defense against any CTD is to try to prevent the injury before it starts. In the case of back injuries, which are the most disabling and costly ones, not only to industry but to the employees affected, primary prevention is complicated by our poor understanding of the etiology or chain of causation of back injury.

Most injuries related to poor ergonomic design of equipment being used, donot begin with a major trauma; most are the product of months or years of mini-trauma.

What can you do now to improve your productivity as well as protect your employees' health?

1. Evaluate your injuries. When and how are injuries occurring? Are your workers aging or out of shape? Are new employees predominately the ones getting hurt? Once the evaluation is done:
2. Redesign the job. Job redesign along with sound ergonomic principles is probably the single most important factor in increasing productivity and reducing worker injuries.

Whether you are revamping an assembly line, or replacing a single piece of equipment, the idea is the same: try to make the job fit the worker; don't try to force fit increasingly diverse workers to the job. This may take the form, in a large company, by providing mechanical lifting devices and using robotics to simple, inexpensive solutions such as ergonomic workstations. This is where Pro-Line hopes to fit into your plans. Since the 1978 debut of the first generation Model HD (still our most popular model) and our retractable ball transfer table, Pro-Line has been the leader in ergonomic workstation design. Since 1978, each year we have introduced new basic model workstations, ergonomic accessories and ergonomic handling devices. In this book you will find what we feel is the "leading edge in modular ergonomics."

Please keep in mind that the field of industrial ergonomic design is still emerging. The products found in these pages are those with broad applications. Many of our orders are designed for a customer's unique application. Start by calling or fax a freehand sketch to your distributor or the factory. We will return your idea as a drawing and with a quotation.

Hi-Tech environments require more than strength, modularity and ergonomic design in their workstations. They want esthetics. Manufacturing furniture can't be as plush as office furniture, but management still wants manufacturing and technical personnel to feel they are working in a professional environment. They are getting away from stringer supported grey legs with holes, tops edged with plastic (the most common fracture point), metal drawers with sharp edges (at knee level). When you consider it, is it fair that an average office employee sits in a \$3,600 cubical and many manufacturing employees sit at \$195 industrial grade benches?

In designing all our products, we have strived to incorporate strength, ergonomic design and esthetics, all along keeping in mind that we want to offer the end result at an affordable price.

Pro-Line is committed to giving you the quality and service you deserve.

Give us a call next time you are putting up a new building, setting up a new line or simply modernizing your production or lab area and you will see you can get the latest designs in ergonomic workstations at a fair price.

Sincerely,



Robert W. Hatfield Jr.

President

HOW TO CONFIGURE A MODULAR WORKSTATION

First select a base model
Example **HD603030PL-H11**

Model HD	Length 60	Width 30	Height 30	Worksurface PL	Color H11
The Prefix designates the model.	The first two numbers designate the length in inches.	The second two numbers designate the width in inches.	The last two numbers designate the height in inches. For Custom Heights this # will change	Select type of worksurface required (PL) Standard Laminate (ESD) ESD Laminate (SM) Solid Maple	Select a color choice from inside back cover.

Next, select optional accessories. See page 57 for an example

Example 1 Part # UR60-H11			Example 2 Part # BH60-H11			Example 3 Part # FR60-H11		
Item	Size	Color	Item	Size	Color	Item	Size	Color
UR	60	H11	BH	60	H11	FR	60	H11
Uprights	60" High	Beige	Bin Holder	60" Long	Beige	Footrest	60" Long	Beige
Example 4 Part # OLF60-H11			Example 5 Part # CSPL1260PL-H11			Example 6 Part # HDLE-6-H11		
Item	Size	Color	Item	Size	Color	Item	Size	Color
OLF	60	H11	CSPL	60	H11	HDLE	6	H11
Light Frame	60" Long	Beige	Shelf	12" x 60"	Beige	Leg Extenders	6" adjustment	Beige

All ESD Stations require ground kits for proper operation. See page 42 for options.

MODEL HD



Standard Height 30"H.

Tops also available in Stainless, Polypropylene, Epoxy Resin, Etc.

"The most workstation for your money."

The esthetics of the Model HD combined with the heavy duty, independent 4 leg design and the almost infinite selection of modular accessories have made this model the workstation of choice for production/lab areas at most every Fortune 500 company in America. With an unbeatable price vs. quality, you cannot go wrong with our most popular model. 2" Square tube legs with high quality paint finish. 1,000 lbs. capacity.

T mold protection around the perimeter of laminate tops. (Matching T mold, laminate face modular drawers to protect operators legs and clothing.)

Optional casters are available to mobilize all basic workstations.

Additional charges apply per station for other heights. All ESD stations require ground kits unless otherwise noted.

Make any unit mobile.. Optional Casters on page 40



BASE PART NO. / SIZE (Indicate custom height)	PLASTIC LAMINATE		E.S.D.		SOLID MAPLE	
	Wgt. lbs	Wgt. Cap	Wgt. lbs	Wgt. Cap	Wgt. lbs	Wgt. Cap
HD4830 "(Hgt)	HD483030PL		HD483030ESD		HD483030SM	
48"Lx30"W	100	1000	100	1000	124	1000
HD6030 "(Hgt)	HD603030PL		HD603030ESD		HD603030SM	
60"Lx30"W	115	1000	115	1000	145	1000
HD7230 "(Hgt)	HD723030PL		HD723030ESD		HD723030SM	
72"Lx30"W	130	1000	130	1000	167	1000
HD9630 "(Hgt)	HD963030PL		HD963030ESD		HD963030SM	
96"Lx30"W	160	1000	160	1000	209	1000
HD4836 "(Hgt)	HD483630PL		HD483630ESD		HD483630SM	
48"Lx36"W	108	1000	108	1000	137	1000
HD6036 "(Hgt)	HD603630PL		HD603630ESD		HD603630SM	
60"Lx36"W	125	1000	125	1000	162	1000
HD7236 "(Hgt)	HD723630PL		HD723630ESD		HD723630SM	
72"Lx36"W	140	1000	140	1000	184	1000
HD9636 "(Hgt)	HD963630PL		HD963630ESD		HD963630SM	
96"Lx36"W	170	1000	170	1000	229	1000

Model HD can be made to accept side uprights for mounting of accessories to either side. **96" long stations include a lower upright support.** For 6" Height adjustment in 1" increments see page 30.

See our stock program on the inside front cover for available colors



**Make any unit mobile...
Optional Casters on page 40**



Utilizing the same accessories as the Model HD, the Model CHD is for those who want the mobility of an independent workstation design but need the front leg recessed for leg clearance. Comes standard with a modesty panel. 850 lbs. capacity.

Optional telescoping legs available shown below.

Standard fixed height 30"H.

Other heights available-
Additional charges apply



LEG EXTENDER

6" leg extenders on 1" increments.

For the model CHD must be ordered at time of work station purchase.

MODEL CHD WORKSTATIONS

THE MODEL CHD

BASE PART NO. / SIZE (Indicate custom height)	PLASTIC LAMINATE		E.S.D.		SOLID MAPLE	
	Wgt. lbs	Wgt. Cap	Wgt. lbs	Wgt. Cap	Wgt. lbs	Wgt. Cap
CHD4830 "(Hgt)	CHD483030PL	CHD483030ESD	CHD483030SM			
48"Lx30"W	117	850	119	850	143	850
CHD6030 "(Hgt)	CHD603030PL	CHD603030ESD	CHD603030SM			
60"Lx30"W	138	850	138	850	168	850
CHD7230 "(Hgt)	CHD723030PL	CHD723030ESD	CHD723030SM			
72"Lx30"W	158	850	158	850	195	850
CHD4836 "(Hgt)	CHD483630PL	CHD483630ESD	CHD483630SM			
48"Lx36"W	126	850	126	850	155	850
CHD6036 "(Hgt)	CHD603630PL	CHD603630ESD	CHD603630SM			
60"Lx36"W	158	850	158	850	195	850
CHD7236 "(Hgt)	CHD723630PL	CHD723630ESD	CHD723630SM			
72"Lx36"W	168	850	168	850	212	850

PART NO.	DESCRIPTION	Wgt. (lbs)
CHDLE-6	6" Leg Extenders for the Model CHD	8



Shown with various accessories

Ergonomists at the world's largest manufacturers have recognized that repetitive motion injury can be greatly reduced and productivity greatly increased by changing positions during the work process. Ergo-Line allows operators of all sizes and physical characteristics to change work surface height at will. Our optional work surface tilting feature is available upon request.

- Adjusts 30" to 42" only.
- 330 lb. capacity.

For other height and weight requirements see the Model ELH on page 3.

ERGO-LINE WORKSTATIONS

BASE PART NO. / SIZE	PLASTIC LAMINATE		E.S.D.		SOLID MAPLE	
	Wgt. lbs	Wgt. Cap	Wgt. lbs	Wgt. Cap	Wgt. lbs	Wgt. Cap
EL4830 30-42"	EL4830PL	EL4830ESD	EL4830SM			
48"Lx30"W	125	330	125	330	150	330
EL4836 30-42"	EL4836PL	EL4836ESD	EL4836SM			
48"Lx36"W	133	330	133	330	162	330
EL6030 30-42"	EL6030PL	EL6030ESD	EL6030SM			
60"Lx30"W	140	330	140	330	170	330
EL6036 30-42"	EL6036PL	EL6036ESD	EL6036SM			
60"Lx36"W	150	330	150	330	187	330
EL7230 30-42"	EL7230PL	EL7230ESD	EL7230SM			
72"Lx30"W	155	330	155	330	192	330
EL7236 30-42"	EL7236PL	EL7236ESD	EL7236SM			
72"Lx36"W	165	330	165	330	209	330

For Electric Hydraulic Push Button Height, consult factory. Part Number changes to **ELE**.

Consult factory for other height ranges, sizes and weight capacities.

See our stock program on the inside front cover for available colors

HEAVY DUTY ERGO LINE – HAND CRANK

BASE PART NO./SIZE Indicate custom height	PLASTIC LAMINATE		E.S.D.		SOLID MAPLE	
	Wgt. lbs	Wgt. Cap	Wgt. lbs	Wgt. Cap	Wgt. lbs	Wgt. Cap
ELH4830 "(Hgt)	ELH4830PL		ELH4830ESD		ELH4830SM	
48"Lx30"W	125	750	125	750	150	750
ELH4836 "(Hgt)	ELH4836PL		ELH4836ESD		ELH4836SM	
48"Lx36"W	133	750	133	750	160	750
ELH6030 "(Hgt)	ELH6030PL		ELH6030ESD		ELH6030SM	
60"Lx30"W	140	750	140	750	170	750
ELH6036 "(Hgt)	ELH6036PL		ELH6036ESD		ELH6036SM	
60"Lx36"W	150	750	150	750	187	750
ELH7230 "(Hgt)	ELH7230PL		ELH7230ESD		ELH7230SM	
72"Lx30"W	155	750	155	750	192	750
ELH7236 "(Hgt)	ELH7236PL		ELH7236ESD		ELH7236SM	
72"Lx36"W	165	750	165	750	209	750
ELH9630 "(Hgt)	ELH9630PL		ELH9630ESD		ELH9630SM	
96"Lx30"W	155	750	155	750	192	750
ELH9636 "(Hgt)	ELH9636PL		ELH9636ESD		ELH9636SM	
96"Lx36"W	165	750	165	750	209	750



750 lb capacity vertical adjust station for applications that our standard 330 lb capacity Ergo Line does not address (Height range 12"). **Standard height adjustment 30" to 42"**. Other heights available - Additional charges apply

For Electric Hydraulic Push Button Height Adjustment add **Prefix ELHE** to the Part number. Additional charges apply, please consult factory

Simply the best ergonomic station ever made.

This is the station for the next millennium.

- **UL and CSA approved motor and control box.**
- **1000 lbs. capacity.**
- **Four-position programmable height memory switch.**
- **Ships "KD" or assembled.**
- **16" of travel.**
- **Unit adjusts from 30.5" to 46.5" only. For other heights see ELHE.**

The MVSII is an electric height adjustable workstation. The unit adjusts from 30.5" to 46.5" with 1000 lbs. capacity at a travel rate of .5" per second. Sturdy but simple design allows unit to ship "KD" or assembled. Unit assembles in the field in minutes. Programmable switch allows operator to program up to three heights into memory or use the up/down switch for full 16" of travel. Our modular drawer system and other under the surface options can be added in the field.

The MVSII is "In Stock" in both 60" L x 30"W and 72" L x 30" W in light blue.

BASE PART NO./SIZE	PLASTIC LAMINATE		E.S.D.		SOLID MAPLE	
	Wgt. lbs	Wgt. Cap	Wgt. lbs	Wgt. Cap	Wgt. lbs	Wgt. Cap
MVSII4830	MVSII4830PL		MVSII4830ESD		MVSII4830SM	
48"Lx30"W	190	1000	190	1000	214	1000
MVSII4836	MVSII4836PL		MVSII4836ESD		MVSII4836SM	
48"Lx36"W	214	1000	214	1000	238	1000
MVSII6030	MVSII6030PL		MVSII6030ESD		MVSII6030SM	
60"Lx30"W	210	1000	210	1000	240	1000
MVSII6036	MVSII6036PL		MVSII6036ESD		MVSII6036SM	
60"Lx36"W	230	1000	230	1000	272	1000
MVSII7230	MVSII7230PL		MVSII7230ESD		MVSII7230SM	
72"Lx30"W	230	1000	230	1000	272	1000
MVSII7236	MVSII7236PL		MVSII7236ESD		MVSII7236SM	
72"Lx36"W	250	1000	250	1000	292	1000



MILLENNIUM II. "STATE OF THE ART" Electric Height Adjustable Workstation

"Are your Production Areas ready for the next Millennium?"



Model MVSII

Shown with optional accessories

See our stock program on the inside front cover for available colors

FLEXLINE SYSTEMS – OVER CONVEYOR!

Pro-Line's FlexLine systems make ideal work stands when a complete workstation is not needed. Pro-Line's modular accessories easily mount to these fully welded structural steel frames. Unit includes two (2) 24" long horizontal leg supports and one open Frame 3.25" thick. 500 lbs. capacity.

Please note when purchasing accessories for FlexLine stations add the letters FL to the end of our part numbers. Please use any accessories in Accessory section.

PART NO.	DESCRIPTION	Wgt. (lbs)
OF3648	Open Frame 36"W x 48"H	51
OF4848	Open Frame 48"W x 48"H	57
OF3666	Open Frame 36"W x 66"H	60
OF4866	Open Frame 48"W x 66"H	65
OF6066	Open Frame 60"W x 66"H	60
OF3680	Open Frame 36"W x 80"H	67
OF4880	Open Frame 48"W x 80"H	74



Open Frames are also available Doublesided



SUSPENDED WORKSURFACE/SHELF

Cantilevers over or under any conveyor. Variety of work surface materials available.

ERGONOMIC POSITIONING AUXILIARY WORKSURFACE

Position monitors, parts bins, subassemblies, etc. for ideal accessibility during work process. Puts the work at your fingertips.



OVERHEAD LIGHTING

Variety of lighting available.



CANTILEVER TOOL BALANCER – Made for any span.

Make any unit mobile....

Optional Casters on page 40

FLEXLINE SYSTEMS

FLEXLINE



Open Frame System allows tops and accessories to be supported off both sides of panel. **Shown as double sided unit.**

Includes open frame supports and work surface. Shown with optional accessories. 750 lbs. capacity.

When ordering accessories for FlexLine stations, add FL to end of part number.

Overall height 69" without light.

Please specify workstation to ship KD or fully assembled.				
TOP	FLEXLINE 48" x 30"		FLEXLINE 60" x 30"	
	PART #	WEIGHT	PART #	WEIGHT
Plastic Single Side	FL4830PL	129	FL6030PL	159
Conductive Single Side	FL4830ESD	129	FL6030ESD	159
Plastic Double Side	FL4830PLD	198	FL6030PLD	241
Conductive Double Side	FL4830ESDD	198	FL6030ESDD	241

PROGRESSIVE ASSEMBLY

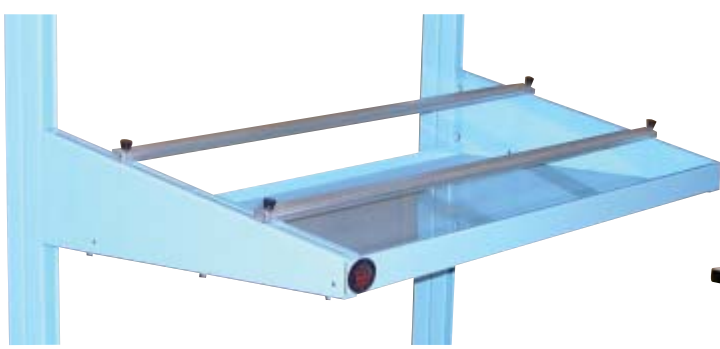

Progressive Assembly rail system for sliding along assembly of PC board modules.

Mounts to Flexline frame.

Can also be mounted to worksurface of other models.

Please Specify Model

PART NO.	DESCRIPTION	Wgt. (lbs)	Wgt. (kgs)
PAS48	Fits 48" Frame / 121.92 cm	19	8.6

TECHNICAL WORKSTATION (COCKPIT STATION)

Similar in construction to the Model HD with a 72" x 42" "T" molded worksurface cut out 30" wide x 18" deep in front. 750 lbs. capacity.

This workstation is popular with technicians who need extra room for instrumentation and documents. Often ordered with shelving, drawers and pull out writing surfaces.



PART NO.	DESCRIPTION	Wgt. (lbs)	Wgt. (kgs)
TW724230P	72"L x 42"W x 30"H 192/88 cm x 106.68 cm x 76.20 cm	148	66

PLEASE CONSULT THE FACTORY FOR ALL YOUR CUSTOM FABRICATION REQUIREMENTS.

TECHNICIAN STATION THE MODEL TSHD

*One great station, one great price,
one easy to order part number.*

The **Model TSHD** comes complete as shown. Price includes base unit 30" or 36" deep and 60" or 72" long (Work surface height adjusts from 30" to 36.) modular draws 6" and 12" with laminate face personal pad lock drawer with hanging kits riser 12" deep x 18" high with 6 pre-wired outlets, and a 90° rolled front edge. ESD stations also include ESD work surface and ESD shelf surface and a standard ground kit with two banana jacks.

The model TSHD is in stock with white surfaces and light blue frames.



Front brace of riser removed to show electrical outlets.

BASE PART NO./ SIZE	Plastic Laminate	ESD Laminate
TSHD6030 60"L x 30"W	TSHD6030PL Wgt (lbs) 254	TSHD6030ESD Wgt (lbs) 255
TSHD7230 72"L x 30"W	TSHD7230PL Wgt (lbs) 278	TSHD7230ESD Wgt (lbs) 278
TSHD6036 60"L x 36"W	TSHD6036PL Wgt (lbs) 264	TSHD6036ESD Wgt (lbs) 265
TSHD7236 72"L x 36"W	TSHD7236PL Wgt (lbs) 288	TSHD7236ESD Wgt (lbs) 288



ENCLOSED CABINET BENCH WITH SLIDING DOORS



Shown with optional light, shelf and power supply.

The **Model ECB/HD** Enclosed Cabinet bench built on the Model HD frame has been in use since 1979. This station allows you to neatly store and secure items in your plant. With our modular design, you can easily add accessories to make this station meet your requirements. (Standard height 30" high) Price includes lock. Other Heights available at an additional charge

BASE PART NO./ SIZE Indicate custom height	PLASTIC LAMINATE		E.S.D.		SOLID MAPLE 13/4"	
ECB4830 "(Hgt)	ECB483030PL		ECB483030ESD		ECB483030SM	
48"Lx30"W	Wgt. lbs 245	Wgt. Cap 1000	Wgt. lbs 245	Wgt. Cap 1000	Wgt. lbs 265	Wgt. Cap 1000
ECB4836 "(Hgt)	ECB483630PL		ECB483630ESD		ECB483630SM	
48"Lx36"W	Wgt. lbs 265	Wgt. Cap 1000	Wgt. lbs 265	Wgt. Cap 1000	Wgt. lbs 285	Wgt. Cap 1000
ECB6030 "(Hgt)	ECB603030PL		ECB603030ESD		ECB603030SM	
60"Lx30"W	Wgt. lbs 275	Wgt. Cap 1000	Wgt. lbs 275	Wgt. Cap 1000	Wgt. lbs 290	Wgt. Cap 1000
ECB6036 "(Hgt)	ECB603630PL		ECB603630ESD		ECB603630SM	
60"Lx36"W	Wgt. lbs 285	Wgt. Cap 1000	Wgt. lbs 285	Wgt. Cap 1000	Wgt. lbs 290	Wgt. Cap 1000
ECB7230 "(Hgt)	ECB723030PL		ECB723030ESD		ECB723030SM	
72"Lx30"W	Wgt. lbs 301	Wgt. Cap 1000	Wgt. lbs 301	Wgt. Cap 1000	Wgt. lbs 326	Wgt. Cap 1000
ECB7236 "(Hgt)	ECB723630PL		ECB723630ESD		ECB723630SM	
72"Lx36"W	Wgt. lbs 321	Wgt. Cap 1000	Wgt. lbs 321	Wgt. Cap 1000	Wgt. lbs 335	Wgt. Cap 1000

PLEASE CONSULT THE FACTORY FOR ALL YOUR CUSTOM FABRICATION REQUIREMENTS.



Shown with optional risers (see page 8)
 For 90 degree rolled front edge additional charges apply
 Easily mix and match cabinets to meet your requirements
 Standard and ESD surfaces come with
 "T" Mold edges standard.

**Available in
Powder Coat
Textured
Finish Only**

Heavy Duty Pedestal Workstations (Series "PCP") featuring Heavy duty Modular Cabinets 18"W x 26"D. Drawers feature 95% extension slides with 100 Lb. capacity per drawer. Drawer insides are slotted to accept optional dividers every 1" for optimal organization.

Stations priced below with 6" high base. Overall height of station with laminate or ESD surface is 35.5" set at the lowest point. Overall height with Maple surface is 36" set at the lowest point. Glides allow for 1" of adjustment, (Other heights available.)

Textured color options shown on Page 52. When ordering two tone color scheme, please specify desired colors for housings and drawers.

Drawer Dividers	
Part No.	wgt
3" DD3	(1.5) lbs
6" DD6	(2.5) lbs
12" DD12	(4.5) lbs



For other divider configurations, see page 57

HEAVY DUTY PEDESTAL WORKSTATIONS (SERIES "PCP")

	Size	Plastic Laminate	E.S.D. Laminate	Solid 1 3/4" Maple		Size	Plastic Laminate	E.S.D. Laminate	Solid 1 3/4" Maple
	60" L x 30"	PCP6030APL Wgt. (lbs)279	PCP6030AESD Wgt. (lbs)279	PCP6030ASM Wgt. (lbs)311		60" L x 30"	PCP6030IPL Wgt. (lbs)312	PCP6030IESD Wgt. (lbs)312	PCP6030ISM Wgt. (lbs)344
	72" L x 30"	PCP7230APL Wgt. (lbs) 291	PCP7230AESD Wgt. (lbs)291	PCP7230ASM Wgt. (lbs)328		72" L x 30"	PCP7230IPL Wgt. (lbs)324	PCP7230IESD Wgt. (lbs)324	PCP7230ISM Wgt. (lbs)361
	60" L x 30"	PCP6030BPL Wgt. (lbs)234	PCP6030BESD Wgt. (lbs)234	PCP6030BSM Wgt. (lbs)266		60" L x 30"	PCP6030JPL Wgt. (lbs)307	PCP6030JESD Wgt. (lbs)307	PCP6030JSM Wgt. (lbs)339
	72" L x 30"	PCP7230BPL Wgt. (lbs)246	PCP7230BESD Wgt. (lbs)246	PCP7230BSM Wgt. (lbs)283		72" L x 30"	PCP7230JPL Wgt. (lbs)319	PCP7230JESD Wgt. (lbs)319	PCP7230JSM Wgt. (lbs)356
	60" L x 30"	PCP6030CPL Wgt. (lbs)256	PCP6030CESD Wgt. (lbs)256	PCP6030CSM Wgt. (lbs)288		60" L x 30"	PCP6030KPL Wgt. (lbs)284	PCP6030KESD Wgt. (lbs)284	PCP6030KSM Wgt. (lbs)316
	72" L x 30"	PCP7230CPL Wgt. (lbs)268	PCP7230CESD Wgt. (lbs)268	PCP7230CSM Wgt. (lbs)305		72" L x 30"	PCP7230KPL Wgt. (lbs)296	PCP7230KESD Wgt. (lbs)296	PCP7230KSM Wgt. (lbs)333
	60" L x 30"	PCP6030DPL Wgt. (lbs)256	PCP6030DES Wgt. (lbs)256	PCP6030DSM Wgt. (lbs)308		60" L x 30"	PCP6030LPL Wgt. (lbs)147	PCP6030LES Wgt. (lbs)147	PCP6030LSM Wgt. (lbs)180
	72" L x 30"	PCP7230DPL Wgt. (lbs)288	PCP7230DES Wgt. (lbs)288	PCP7230DSM Wgt. (lbs)325		72" L x 30"	PCP7230LPL Wgt. (lbs)296	PCP7230LES Wgt. (lbs)296	PCP7230LSM Wgt. (lbs)333
	60" L x 30"	PCP6030EPL Wgt. (lbs)264	PCP6030EESD Wgt. (lbs)264	PCP6030ESM Wgt. (lbs)296		60" L x 30"	PCP6030MPL Wgt. (lbs)158	PCP6030MESD Wgt. (lbs)158	PCP6030MSM Wgt. (lbs)190
	72" L x 30"	PCP7230EPL Wgt. (lbs)276	PCP7230EESD Wgt. (lbs)276	PCP7230ESM Wgt. (lbs)313		72" L x 30"	PCP7230MPL Wgt. (lbs)170	PCP7230MESD Wgt. (lbs)170	PCP7230MSM Wgt. (lbs)207
	60" L x 30"	PCP6030FPL Wgt. (lbs)290	PCP6030FESD Wgt. (lbs)290	PCP6030FSM Wgt. (lbs)322		60" L x 30"	PCP6030NPL Wgt. (lbs)175	PCP6030NESD Wgt. (lbs)175	PCP6030NSM Wgt. (lbs)207
	72" L x 30"	PCP7230FPL Wgt. (lbs)302	PCP7230FESD Wgt. (lbs)302	PCP7230FSM Wgt. (lbs)302		72" L x 30"	PCP7230NPL Wgt. (lbs)187	PCP7230NESD Wgt. (lbs)187	PCP7230NSM Wgt. (lbs)224
	60" L x 30"	PCP6030GPL Wgt. (lbs) 284	PCP6030GESD Wgt. (lbs)284	PCP6030GSM Wgt. (lbs)316		60" L x 30"	PCP6030OPL Wgt. (lbs)182	PCP6030OESD Wgt. (lbs)182	PCP6030OSM Wgt. (lbs)214
	72" L x 30"	PCP7230GPL Wgt. (lbs) 296	PCP7230GESD Wgt. (lbs)296	PCP7230GSM Wgt. (lbs)333		72" L x 30"	PCP7230OPL Wgt. (lbs)194	PCP7230OESD Wgt. (lbs)194	PCP7230OSM Wgt. (lbs)231
	60" L x 30"	PCP6030HPL Wgt. (lbs)300	PCP6030HESD Wgt. (lbs)300	PCP6030HSM Wgt. (lbs)332		60" L x 30"	PCP6030PPL Wgt. (lbs)182	PCP6030PESD Wgt. (lbs)182	PCP6030PSM Wgt. (lbs)214
	72" L x 30"	PCP7230HPL Wgt. (lbs) 312	PCP7230HESD Wgt. (lbs)312	PCP7230HSM Wgt. (lbs)349		72" L x 30"	PCP7230PPL Wgt. (lbs)326	PCP7230PESD Wgt. (lbs)326	PCP7230PSM Wgt. (lbs)363

Gang Locks Sold separately

(Cabinet workstations placed back to back require two (2) risers or special 24" wide risers available upon request.) Double tier risers also available upon request. **Note: Risers are 18" in height.** Risers shown with optional S-2 panel.

MODULAR INSTRUMENT SHELF

See our stock program on the inside front cover for available colors



No Electrical Outlets.

12" WIDE	SIZE	Plastic Laminate	E.S.D. Laminate	Solid 1 3/4" Maple
	60" x 12"	R6012-1PL Wgt. (lbs) 41	R6012-1ESD Wgt. (lbs) 41	R6012-1SM Wgt. (lbs) 51
72" x 12"	R7212-1PL Wgt. (lbs) 48	R7212-1ESD Wgt. (lbs) 48	R7212-1SM Wgt. (lbs) 58	
60" x 12"	R6012-2PL Wgt. (lbs) 43	R6012-2ESD Wgt. (lbs) 43	R6012-2SM Wgt. (lbs) 53	
72" x 12"	R7212-2PL Wgt. (lbs) 50	R7212-2ESD Wgt. (lbs) 50	R7212-2SM Wgt. (lbs) 60	

18" WIDE	SIZE	Plastic Laminate	E.S.D. Laminate	Solid Maple
	60" x 18"	R6018-1PL Wgt. (lbs) 46	R6018-1ESD Wgt. (lbs) 46	R6018-1SM Wgt. (lbs) 55
72" x 18"	R7218-1PL Wgt. (lbs) 53	R7218-1ESD Wgt. (lbs) 53	R7218-1SM Wgt. (lbs) 61	
60" x 18"	R6018-2PL Wgt. (lbs) 46	R6018-2ESD Wgt. (lbs) 46	R6018-2SM Wgt. (lbs) 55	
72" x 18"	R7218-2PL Wgt. (lbs) 53	R7218-2ESD Wgt. (lbs) 53	R7218-2SM Wgt. (lbs) 61	



Electrical Outlets in One Leg.

12" WIDE	SIZE	Plastic Laminate	E.S.D. Laminate	Solid 1 3/4" Maple
	60" x 12"	R6012-3PL Wgt. (lbs) 46	R6012-3ESD Wgt. (lbs) 46	R6012-3SM Wgt. (lbs) 56
72" x 12"	R7212-3PL Wgt. (lbs) 53	R7212-3ESD Wgt. (lbs) 53	R7212-3SM Wgt. (lbs) 63	
60" x 12"	R6012-4PL Wgt. (lbs) 47	R6012-4ESD Wgt. (lbs) 47	R6012-4SM Wgt. (lbs) 57	
72" x 12"	R7212-4PL Wgt. (lbs) 54	R7212-4ESD Wgt. (lbs) 54	R7212-4SM Wgt. (lbs) 64	

18" WIDE	SIZE	Plastic Laminate	E.S.D. Laminate	Solid 1 3/4" Maple
	60" x 18"	R6018-3PL Wgt. (lbs) 46	R6018-3ESD Wgt. (lbs) 46	R6018-3SM Wgt. (lbs) 55
72" x 18"	R7218-3PL Wgt. (lbs) 53	R7218-3ESD Wgt. (lbs) 53	R7218-3SM Wgt. (lbs) 61	
60" x 18"	R6018-4PL Wgt. (lbs) 46	R6018-4ESD Wgt. (lbs) 46	R6018-4SM Wgt. (lbs) 55	
72" x 18"	R7218-4PL Wgt. (lbs) 53	R7218-4ESD Wgt. (lbs) 53	R7218-4SM Wgt. (lbs) 61	



Electrical Outlets Across Rear Brace.



Electrical Outlets Both Legs.

18" Wide Shelves have a 4" overhang front and rear.

Riser Shelf Surfaces Standard or ESD laminate with "T" mold

Pro-Line's Riser shelves turn any of our stations into a Technical Work Station. Heavy gauge painted steel frame easily mounts to all of our models. The -3 includes 6 built-in 15 amp 120-volt electrical outlets across rear support.



S-2P Electrical Panel

The S-2EP electrical panel allows you to add additional outlets to either -1 or -2 riser shelves. Price includes panel with 6 outlets on/off switch, built-in circuit breaker and power cord.

S-2EP
Wgt. (lbs) 8



GRE Riser Extensions

Optional enclosure panel for riser leg.

S-2
Wgt. (lbs) 2.5

The 6RE is a pair of 6" riser extensions. Raises height of riser to 24" overall height.

6RE
Wgt. (lbs) 12/pr

LAN STATION

These units are priced complete with a 24" x 36" worksurface, two AMS1836, MA-1, CPU holder, power supply and wire management trough. Standard unit is 36" wide x 66" high and 36" wide x 80" high. Easily bolts together to make unit as long as you need.

PART NO.	DESCRIPTION	Wgt. (lbs)
LAN3666	36" Wide x 66" High	145
LAN3680	36" Wide x 80" High	165

For additional LAN Stations see page 24.



CPU HOLDER

CPU Holder mounts under work surface for convenient storage of CPU. Painted steel to match workstation.

PART NO.	DESCRIPTION	Wgt. (lbs)
CPU	8"W x 18"D x 18"H I.D.	15

Requires CPUHK hanging kit.

BACK LIGHT STATIONS

Light fixture beneath surface illuminates translucent plastic top. For film inspection, these units are used mainly in optical and medical applications. Built on our model CHD design 120 volt 15 amp.

PART NO.	DESCRIPTION	Wgt. (lbs)
BL483030	Back Light Station 60"L x 30"W	235
BL483630	Back Light Station 60"L x 36"W	240



Standard Height 30"

Other heights available- Additional charges apply
Height Adjustable with Tilt Available

Shown with optional tilt. Add ET-1 See page 36.
Shown with optional MVSII base

PLEASE CONSULT THE FACTORY FOR ALL YOUR CUSTOM FABRICATION REQUIREMENTS.

“EASY GLIDER” • “POP UP BALL TRANSFERS”

“Pop Up” Ball transfers assist in transfer and positioning of materials in production. Ball transfers raise .250" above surface by activating pneumatic toggle switch. Work in process is then slid on to station. When load is in position, ball transfers are retracted and load is stabilized. Standard stations require 80 PSI of shop air to operate. Retractable ball transfer stations are available in half or full length coverage of surface. Two ball patterns are available: standard 6" x 6" pattern and heavy duty 3" x 6". Modular design allows for mounting of optional accessories. Stations feature a solid maple surface or an E.S.D., Electro Static Discharge Top. Heavy Duty 2" square tubular legs offer stability and esthetics. Leg extenders allow surface height to be set from 30" to 36". Footrest included.

**Optional foot pedal control available at an additional charge
Not Shown**

Lever Operated Transfer Stations require no shop air.



Handle Mounts on left front corner not as shown.

Additional charges apply for Lever Operation
Add "L to the end of part#



Photo shown with optional accessories.

SD-Standard Density 6" x 6" Ball Pattern

HALF COVERAGE SD	PART NO.	Wgt.	Cap. Lbs.	MAPLE CONDUCTIVE
	RT4830HCSDM	150	200	
	RT4836HCSDM	160	200	
	RT6030HCSDM	170	200	
	RT6036HCSDM	180	200	
	RT7230HCSDM	185	200	
	RT7236HCSDM	195	200	
	RT4830HCSDC	140	200	
	RT4836HCSDC	150	200	
	RT6030HCSDC	160	200	
	RT6036HCSDC	170	200	
RT7230HCSDC	175	200		
RT7236HCSDC	185	200		

FULL COVERAGE SD	PART NO.	Wgt.	Cap. Lbs.	MAPLE CONDUCTIVE
	RT4830FCSDM	185	400	
	RT4836FCSDM	195	400	
	RT6030FCSDM	205	400	
	RT6036FCSDM	225	400	
	RT7230FCSDM	225	400	
	RT7236FCSDM	235	400	
	RT4830FCSDC	165	400	
	RT4836FCSDC	170	400	
	RT6030FCSDC	195	400	
	RT6036FCSDC	175	400	
RT7230FCSDC	210	400		
RT7236FCSDC	220	400		

M-Solid Maple HC-Half Coverage

When ordering HC please specify Left or Right.

HD-High Density 3" x 6" Ball Pattern

HALF COVERAGE HD	PART NO.	Wgt.	Cap. Lbs.	MAPLE CONDUCTIVE
	RT4830HCHDM	162	400	
	RT4836HCHDM	172	400	
	RT6030HCHDM	180	400	
	RT6036HCHDM	190	400	
	RT7230HCHDM	205	400	
	RT7236HCHDM	205	400	
	RT4830HCHDC	152	400	
	RT4836HCHDC	162	400	
	RT6030HCHDC	170	400	
	RT6036HCHDC	180	400	
RT7230HCHDC	195	400		
RT7236HCHDC	210	400		

FULL COVERAGE HD	PART NO.	Wgt.	Cap. Lbs.	MAPLE CONDUCTIVE
	RT4830FCHDM	197	800	
	RT4836FCHDM	207	800	
	RT6030FCHDM	225	800	
	RT6036FCHDM	235	800	
	RT7230FCHDM	245	800	
	RT7236FCHDM	265	800	
	RT4830FCHDC	177	800	
	RT4836FCHDC	187	800	
	RT6030FCHDC	215	800	
	RT6036FCHDC	187	800	
RT7230FCHDC	222	800		
RT7236FCHDC	232	800		

C-Conductive FC-Full Coverage

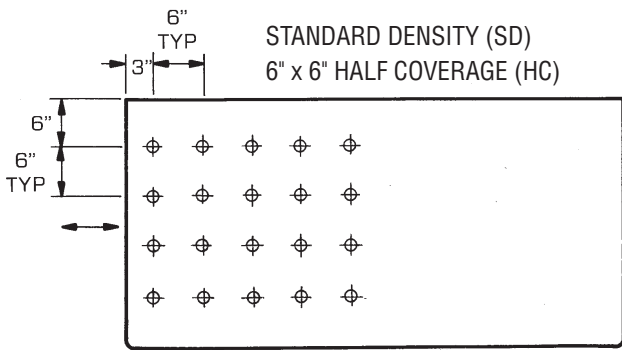

STANDARD BALL TRANSFER LAYOUTS

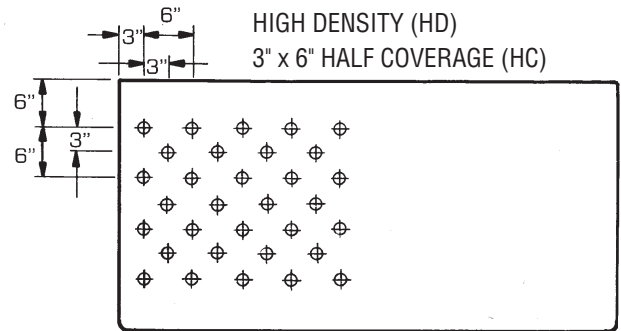

When ordering HC half coverage please specify Transfers on Left or Right.

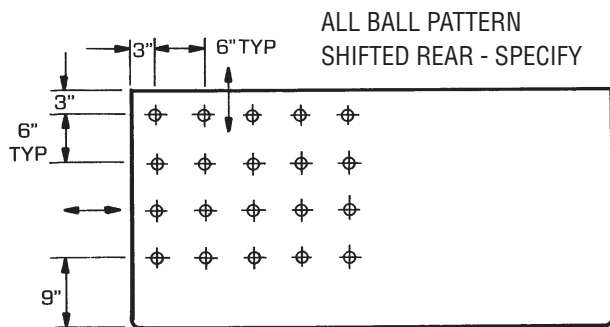
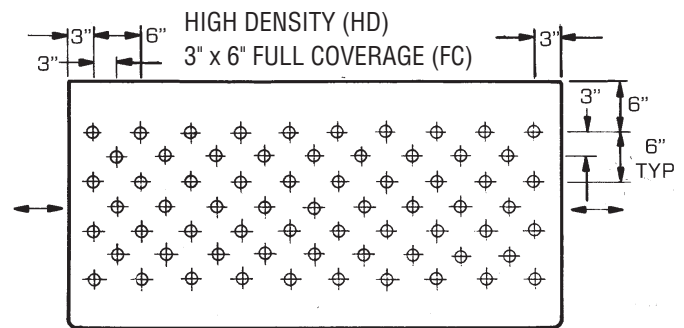
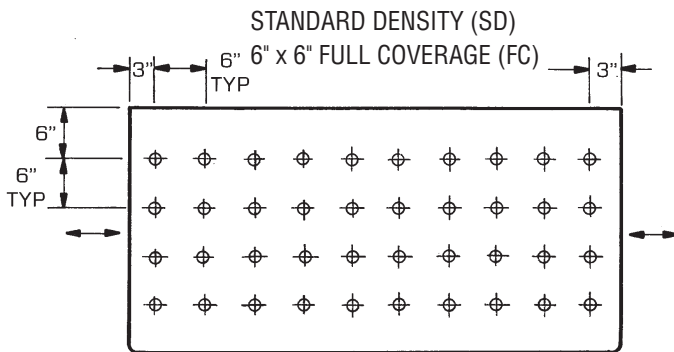

**NOTE:
SIZES SHOWN ARE 60" x 30"
(TOP SURFACE)**

HEIGHT ADJUSTABLE RT STATIONS

Add hand crank or electric height adjustment to the retractable ball transfer stations. 12" adjustment standard range is from 30" to 42" (please specify) 750 lbs capacity. Upcharge price includes 4 post system and a modesty panel and Footrest.

Add letters as a prefix. ie: ELHRT designates hand crank height adjustable retractable ball transfer



ELH and ELE can be added to all four post benches except the model CPB on page 20. Must be ordered at time of workstation purchase.

ELH UPCHARGE

PART NO.	DESCRIPTION	Wgt. (lbs)
ELH	Upcharge to add 4 post Hand crank height adjustment	25
ELE	Upcharge to add 4 post Push button electric height adjustment	45

BUILT IN GRAVITY ROLLER CONVEYOR

Do you manufacture on a progressive assembly line?

These units allow product to roll from one station to the next with a 12" x 12" Retractable Ball Transfer section in the center of the surface. 1" dia. x 12"L Rollers are set on 3" centers on either side of ball transfers. Transfers, when up, are set at same height as roller which allows product to be rotated. 200 lbs. capacity. Priced with standard laminate work surface. Please consult factory for other work surface choices

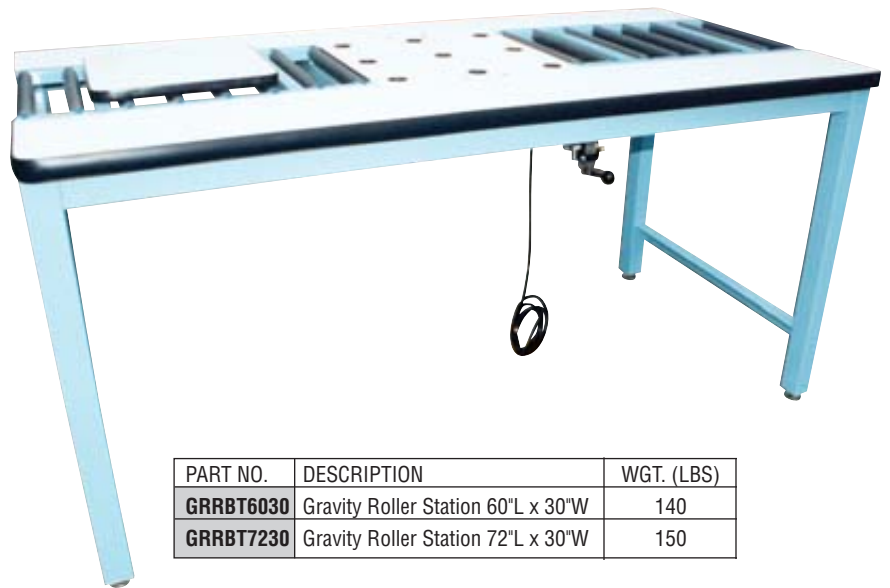

PART NO.	DESCRIPTION	WGT. (LBS)
GRRBT6030	Gravity Roller Station 60"L x 30"W	140
GRRBT7230	Gravity Roller Station 72"L x 30"W	150

FIXED BALL TRANSFER TABLES

Fixed Ball Transfer Tables with ball casters surface mounted or recessed to match level of RBT unit also available. **(Shown with optional casters, making the cart mobile.)** 800 lbs. capacity. Priced with standard laminate work surface. Please consult factory for other work surface choices

Optional handle available at an additional charge



For Optional Casters See Page 40

HIGH DENSITY

PART NO.	DESCRIPTION	Wgt. (lbs)
BT483030-HD	48"L x 30"W 3x6 121.92cm x 76.20cm x 76.20cm	128
BT483630-HD	48"L x 36"W 3x6 121.92cm x 91.44cm x 76.20cm	145
BT603030-HD	60"L x 30"W 3x6 152.40cm x 76.20cm x 76.20cm	153
BT603630-HD	60"L x 36"W 3x6 152.40cm x 91.44cm x 76.20cm	172
BT723030-HD	72"L x 30"W 3x6 182.88cm x 76.20cm x 76.20cm	170
BT723630-HD	72"L x 36"W 3x6 182.88cm x 91.44cm x 76.20cm	197

STANDARD DENSITY

PART NO.	DESCRIPTION	Wgt. (lbs)
BT483030-SD	48"L x 30"W 6x6 121.92cm x 76.20cm x 76.20cm	117
BT483630-SD	48"L x 36"W 6x6 121.92cm x 91.44cm x 76.20cm	128
BT603030-SD	60"L x 30"W 6x6 152.40cm x 76.20cm x 76.20cm	135
BT603630-SD	60"L x 36"W 6x6 152.40cm x 91.44cm x 76.20cm	150
BT723030-SD	72"L x 30"W 6x6 182.88cm x 76.20cm x 76.20cm	154
BT723630-SD	72"L x 36"W 6x6 182.88cm x 91.44cm x 76.20cm	176

PRO-FLOW BELT CONVEYOR STATION

Variable speed belt conveyor built into our popular cantilever workstation. Works great with progressive assembly applications. UHMW work surface makes it easy to slide product on and off conveyor. Belts come in both standard and ESD polypropylene. Just pop in place side by side and plug in!

Standard Features include

- Modular Plug and Play Design (units are prewired to be put into a line and plug into each other)
- Variable speed control (from 2 to 25 FPM)
- Premium polymer flat chain belting (ideal for low pressure accumulation)
- Self tracking / no tensioning required
- Energy efficient 115V AC (0.5 AMP)
- No scheduled maintenance
- Available in four widths 9", 12", 15" or 18"
- Belt capacity 100 lbs

Standard bench size is 60"L x 30"D. For other sizes consult factory. Standard height 34". Other heights available at an additional charge (Please specify at time of order.)

Please specify direction of belt.

PART NO.	DESCRIPTION	Wgt. (lbs)
BC60309	Workstation with 9" belt	161
BC603012	Workstation with 12" belt	168
BC603015	Workstation with 15" belt	175
BC603018	Workstation with 18" belt	182
BC60309ESD	Workstation with 9" ESD belt	161
BC603012ESD	Workstation with 12" ESD belt	168
BC603015ESD	Workstation with 15" ESD belt	175
BC603018ESD	Workstation with 18" ESD belt	182

(Shown with optional accessories above work surface.)

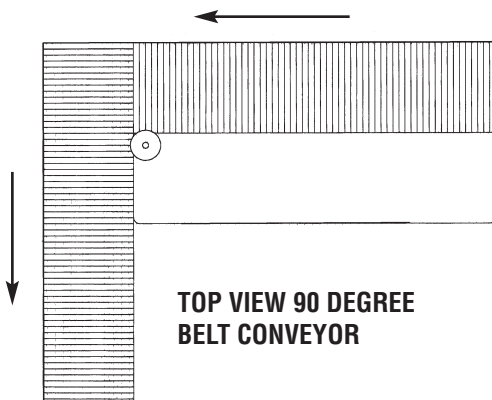

Manual Lifting: A backbone of Back injuries

11 million cases of back pain reported by workers are work-related —a significant fraction is linked to lifting

...12% of these workers stopped working or changed jobs due to back pain

...And they lost 543 million working days

Back injuries account for 20% of all injuries/illnesses in the workplace

Bad backs result in 25% of total workers compensation claims

BASE WORKSTATIONS

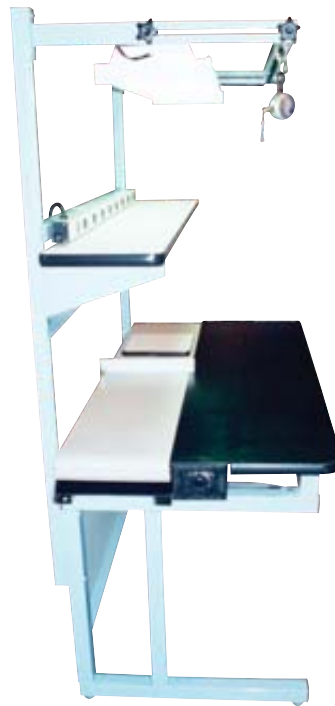

BELT CAN BE MOUNTED TO THE FRONT OF THE WORKSTATION AS WELL. PLEASE SPECIFY WHEN ORDERING



Station shown with optional accessories

DIMENSION NEXT

MODULAR TECHNICAL SYSTEMS

'DIMENSION NEXT' EXPANDABLE MODULAR WORK STATIONS

Top quality finish meets modular ergonomic function with a price that is still affordable.

Solid slotted aluminum uprights allow work surface or optional accessories to be mounted anywhere along column. Heavy gauge steel frame bolts to top supports adding strength to the work surface and lateral support to the station. **In stock colors are textured beige powder coat finish with blue accents strips** offers a durable finish with superior esthetics. Stations are 82" over all height. Work surfaces and optional accessories adjust independently of each other on double sided stations. 1000 lbs. capacity.

• Single sided starter station includes two uprights, two horizontal leg supports, one top frame assembly and one 180 degree front edge work surface with standard or ESD laminate.

• Single sided add-on station includes one upright, one horizontal leg support, one top frame assembly and one 180 degree front edge work surface with standard or ESD laminate.

• Double sided starter station includes two uprights, two back to back horizontal leg supports, two top frame assemblies and two 180 degree work surfaces with standard or ESD laminate.

• Double sided add-on station includes one upright, one back to back horizontal leg support, two top frame assemblies and two 180 degree front edge work surfaces with standard or ESD laminate.

(each row requires one starter unit)

In Stock 60" & 72" Long



Available in
Powder Coat
Textured
Finish Only

Textured color options shown on page 52

Base Part NO./ Size	Plastic Laminate	ESD Laminate
DN4830SS 48"L x 30"W Single Starter	DN4830SSPL Wgt. (lbs) 177	DN4830SSESD Wgt. (lbs) 177
DN6030SS 60"L x 30"W Single Starter	DN6030SSPL Wgt. (lbs) 198	DN6030SSESD Wgt. (lbs) 198
DN7230SS 72"L x 30"W Single Starter	DN7230SSPL Wgt. (lbs) 217	DN7230SSESD Wgt. (lbs) 217
DN4830SA 48"L x 30"W Single Add-On	DN4830SAPL Wgt. (lbs) 130	DN4830SAESD Wgt. (lbs) 130
DN6030SA 60"L x 30"W Single Add-On	DN6030SAPL Wgt. (lbs) 148	DN6030SAESD Wgt. (lbs) 148
DN7230SA 72"L x 30"W Single Add-On	DN7230SAPL Wgt. (lbs) 168	DN7230SAESD Wgt. (lbs) 168

Base Part NO./ Size	Plastic Laminate	ESD Laminate
DN4830DS 48"L x 30"W Double Starter	DN4830DSPL Wgt. (lbs) 280	DN4830DSESD Wgt. (lbs) 280
DN6030DS 60"L x 30"W Double Starter	DN6030DSPL Wgt. (lbs) 307	DN6030DSESD Wgt. (lbs) 307
DN7230DS 72"L x 30"W Double Starter	DN7230DSPL Wgt. (lbs) 360	DN7230DSESD Wgt. (lbs) 360
DN4830DA 48"L x 30"W Double Add-On	DN4830DAPL Wgt. (lbs) 220	DN4830DAESD Wgt. (lbs) 220
DN6030DA 60"L x 30"W Double Add-On	DN6030DAPL Wgt. (lbs) 260	DN6030DAESD Wgt. (lbs) 260
DN7230DA 72"L x 30"W Double Add-On	DN7230DAPL Wgt. (lbs) 300	DN7230DAESD Wgt. (lbs) 300

OPTIONAL ACCESSORIES FOR THE DIMENSION NEXT

Dimension Next optional modular accessories allow you to configure your station to meet your needs. Easily adjustable in the field the Dimension Next options adjust anywhere along upright. Adjustments are made with handles included in the price of the options. No tools are required to make adjustments. All of the model DN options are painted with a textured powder coat finish for years of use.

PART NO.	DESCRIPTION	WGT. (LBS)
DNFR48	Height adjustable and pivoting footrest pan fits 48" long DN stations.	21
DNFR60	Height adjustable and pivoting footrest pan fits 60" long DN stations.	27
DNFR72	Height adjustable and pivoting footrest pan fits 72" long DN stations.	33
DNES48	Power supply with 8 outlets, lighted on/off switch, built in circuit breaker and 6' long cord. Fits 48" long DN stations.	12
DNES60	Power supply with 8 outlets, lighted on/off switch, built in circuit breaker and 6' long cord. Fits 60" long DN stations.	16
DNES72	Power supply with 8 outlets, lighted on/off switch, built in circuit breaker and 6' long cord. Fits 72" long DN stations.	20
DNBH48	Bin Holder for a 48" long DN station.	10
DNBH60	Bin Holder for a 60" long DN station.	13
DNBH72	Bin Holder for a 72" long DN station.	16
DNCCUP	Corner Unit for 30" deep model DN	25
DNCCUC	Corner Unit with ESD laminate	25

PART NO.	DESCRIPTION	WGT. (LBS)
DNOLF48	Over head light fixture and frame. Price includes dual bulb fixture with lighted on/off switch and a 9' long cord, for a 48" long DN station.	30
DNOLF60	Over head light fixture and frame. Price includes dual bulb fixture with lighted on/off switch and a 9' long cord, for a 60" long DN station.	30
DNOLF72	Over head light fixture and frame. Price includes dual bulb fixture with lighted on/off switch and a 9' long cord, for a 72" long DN station.	32
DNAMS1248	Adjustable metal shelf 12" deep x 48" long.	32
DNAMS1260	Adjustable metal shelf 12" deep x 60" long.	32
DNAMS1272	Adjustable metal shelf 12" deep x 72" long.	39
DNAMS1848	Adjustable metal shelf 18" deep x 48" long.	39
DNAMS1860	Adjustable metal shelf 18" deep x 60" long.	39
DNAMS1872	Adjustable metal shelf 18" deep x 72" long.	39
MDS6	Modular Drawer 6" high x 15" wide x 19.25" long. Price includes lock. Features include roller bearing guide and white laminate drawer face with rounded corners.	26
MDS12	Modular Drawer 12" high x 15" wide x 19.25" long. Price includes lock. Features include roller bearing guide and white laminate drawer face with rounded corners.	38
HK	Drawer Hanging Kit (one required per station with drawers.)	1.15
SGK-J2	Standard Ground Kit with 2 banana jacks. (For ESD stations only.)	0.5



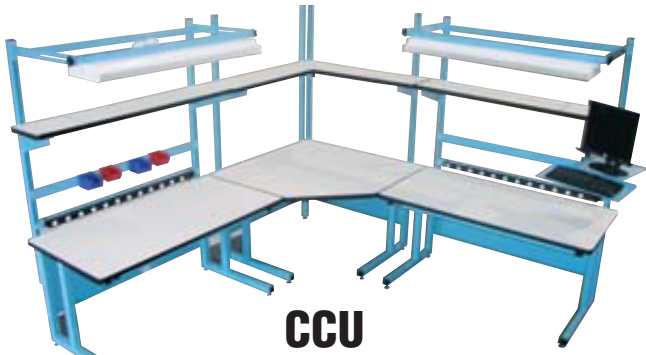

CCU

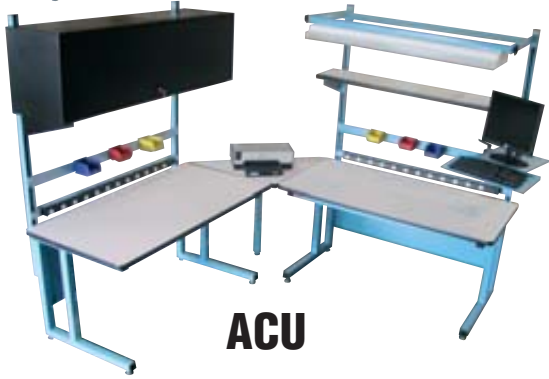

ACU

CORNER UNITS

Need to set up your work stations in an “L” shape configuration?

Pro-Line’s work stations are easily configured to meet your layout as illustrated in these photographs. With two corner units to choose from. The ACU aisle corner unit is designed to set corner units on an aisle. This triangular piece comes complete with mounting hardware and supports. The CCU corner unit is a free standing unit designed to set in corners. Just slide two stations up to it and you have an “L” shape.

Surfaces priced with “T” mold edges.
Additional charges apply for self edge.

PART NO.	DESCRIPTION	PLASTIC LAMINATE		E.S.D.	
		Wgt. lbs	Wgt. Cap	Wgt. lbs	Wgt. Cap
ACU30	Corner Unit for a 30" Deep Station	ACU30PL		ACU30ESD	
		22	150	22	150
ACU36	Corner Unit for a 36" Deep Station	ACU36PL		ACU36ESD	
		28	150	28	150
CCU30	Free Standing Corner Unit for a 30" Deep Station	CCU30PL		CCU30ESD	
		78	750	78	750
CCU36	Free Standing Corner Unit for a 36" Deep Station	CCU36PL		CCU36ESD	
		88	750	88	750

“L” Shaped Workbenches, Fixed and Height adjustable.

Built on the models EL and CHD “L” shaped benches are ideal for both office and industry. Height adjustable unit comes with three post hydraulic system. Rear surface depth is 30”, side surface is 24” deep. (Pro-line’s standard 72” long options mount to the “L” units.)



ELL7272



CHDL7272

“L” SHAPED UNITS

PART NO.	DESCRIPTION	PLASTIC LAMINATE		E.S.D.	
		Wgt. lbs.	Wgt. Cap.	Wgt. lbs.	Wgt. Cap.
ELL7272	72" Long x 72" Long	ELL7230PL		ELL7230ESD	
	Unit adjusts from 30" to 42" Surface is two pieces	205	600	205	600
CHDL7272	72" Long x 72" Long	CHDL7230PL		CHDL7230ESD	
	Fixed Height 30" High Surface is two pieces	205	750	205	750

CORNER SHELVES for the CCU30 and CCU36

Corner shelf units are available for both the CCU30 and CCU36. Shelves are 12" or 18" deep. Price includes mounting bracket and hardware.

CCU Free Standing Corner Unit



When ordering corners, please confirm station height

PART NO.	PLASTIC LAMINATE	E.S.D. LAMINATE
CCUCSPL12	CCUCSPL12PL	CCUCSPL12ESD
48"Lx48"Lx12"W	Wgt. lbs 41	Wgt. lbs 41
CCUCSPL18	CCUCSPL18PL	CCUCSPL18ESD
48"Lx48"Lx18"W	Wgt. lbs 48	Wgt. lbs 48



Note: 2 pair of uprights are required per corner unit



NEW TO THE STOCK PROGRAM 'THE BASICS' 60" & 72" IN STOCK

The Basics is similar in design to our Flexline system. The accessory uprights are included in the base station and the work surface adjusts from 30" to 36" high on 1" increments. From floor to top of frame is 65" high. The Basics station and frame bolt together to keep freight cost down and to minimize storage space when not in use. The Basics is available as a single sided stand alone station or a double sided stand alone station. To help keep cost down, add on stations are available for both the single sided and double sided stations.

Single Sided stations come complete with frame, two top supports, two horizontal leg supports and one worksurface.

Double Sided stations come complete with frame, four top supports, four horizontal leg supports and two worksurfaces.

Add on stations share a top support and a horizontal leg.

IN STOCK COLORS

- Frames are painted with a durable circuit blue powder coat. (Standard color for the Basics Model).
- Options are painted with a durable textured black powder coat.

BASE PART NO./SIZE	Plastic Laminate	ESD Laminate	IN STOCK	QS
B4830SS 48"L x 30"W Single Starter	B4830SSPL Wgt. (lbs) 110	B4830SSESD Wgt. (lbs) 110		
B6030SS 60"L x 30"W Single Starter	B6030SSPL Wgt. (lbs) 140	B6030SSESD Wgt. (lbs) 140	IN STOCK	QS
B7230SS 72"L x 30"W Single Starter	B7230SSPL Wgt. (lbs) 170	B7230SSESD Wgt. (lbs) 170		QS
B4830SA 48"L x 30"W Single Add On	B4830SAPL Wgt. (lbs) 100	B4830SAESD Wgt. (lbs) 100	IN STOCK	
B6030SA 60"L x 30"W Single Add On	B6030SAPL Wgt. (lbs) 130	B6030SAESD Wgt. (lbs) 130		QS
B7230SA 72"L x 30"W Single Add On	B7230SAPL Wgt. (lbs) 160	B7230SAESD Wgt. (lbs) 160	IN STOCK	QS

BASE PART NO./SIZE	Plastic Laminate	ESD Laminate	IN STOCK	QS
B4830DS 48"L x 30"W Double Starter	B4830DSPL Wgt. (lbs) 219	B4830DSESD Wgt. (lbs) 219		
B6030DS 60"L x 30"W Double Starter	B6030DSPL Wgt. (lbs) 269	B6030DSESD Wgt. (lbs) 269	IN STOCK	QS
B7230DS 72"L x 30"W Double Starter	B7230DSPL Wgt. (lbs) 319	B7230DSESD Wgt. (lbs) 319		QS
B4830DA 48"L x 30"W Double Add On	B4830DAPL Wgt. (lbs) 179	B4830DAESD Wgt. (lbs) 179	IN STOCK	
B6030DA 60"L x 30"W Double Add On	B6030DAPL Wgt. (lbs) 229	B6030DAESD Wgt. (lbs) 229		QS
B7230DA 72"L x 30"W Double Add On	B7230DAPL Wgt. (lbs) 279	B7230DAESD Wgt. (lbs) 279	IN STOCK	QS



Options unique to the Basics Station.

The modular accessories shown with the Basics station are unique to this model.

When ordering optional accessories shown, please use graph to the right.

For power supply or other optional accessories shown in our catalogue, please use the suffix FL at the end of the part number.

Example: ESMR48FL for a 48" long Electrical Strip mounting rail.

PART NO.	DESCRIPTION	Wgt. (lbs)
BOLF48	Over head dual bulb light and frame for 48" L Basics.	28
BOLF60	Over head dual bulb light and frame for 60" L Basics.	30
BOLF72	Over head dual bulb light and frame for 72" L Basics.	32
BMCS1248	Metal Cantilever Shelf 12"D x 48"L For 48" Basics.	22
BMCS1260	Metal Cantilever Shelf 12"D x 60"L For 60" Basics.	27
BMCS1272	Metal Cantilever Shelf 12"D x 72"L For 72" Basics.	32
BBH48	Parts Bin Holder for a 48"L Basics.	10
BBH60	Parts Bin Holder for a 60"L Basics.	13
BBH72	Parts Bin Holder for a 72"L Basics.	16



NEW TO THE STOCK PROGRAM 'THE BASICS' 60" & 72" IN STOCK



**STARTER AND ADD-ON WITH
OPTIONAL ACCESSORIES**



**DOUBLE SIDED STARTER DOUBLE SIDED
ADD-ON CONFIGURED IN A "QUAD"**



**SHOWN WITH BCCU30
CORNER UNITS**

WIRE HARNESS ASSEMBLY STATIONS

The MWH and the EWH models are designed for the ergonomic assembly of wire harnesses. Both models feature a 72" long x 36" wide platform capable of holding boards from 24" wide x 24" long up to 48" wide x 96" long. Both models incorporate an adjustable front guardrail that captivates boards from .250" to .750" thick. The EWH features a 60 degree electric foot pedal operated tilt with 600 pounds capacity. When the EWH is fully tilted, the front edge of board adjusts from 24.5" to 40.5" high via foot pedal operation. The MWH features a 60 degree, 13 position manual tilt. When the MWH is fully tilted, the front edge of the board adjusts from 24" to 36" via hand crank.



EWH 7236



MWH 7236

PART NO.	DESCRIPTION	Wgt. (lbs)
MWH7236 72"Lx36"W	Wire harness table with a 72"L x 36" W platform to hold wire harness assembly boards. With hand crank height adjustment and manual tilt.	240
EWH7236 72"Lx36"W	Wire harness table with a 72"L x 36" W platform to hold wire harness assembly boards. With electric height adjustment and electric tilt.	327

THE EST EXHAUST STATION

Standard height 30.5 to 46.5 high

EXHAUST STATIONS

BASE PART NO./SIZE	HDPE	ESD
EST4830 48"L x 30"W	EST4830HDPE Wgt (lbs) 295	EST4830ESD Wgt (lbs) 295
EST4836 48"L x 36"W	EST4836HDPE Wgt (lbs) 301	EST4836ESD Wgt (lbs) 301
EST6030 60"L x 30"W	EST6030HDPE Wgt (lbs) 325	EST6030ESD Wgt (lbs) 325
EST6036 60"L x 36"W	EST6036HDPE Wgt (lbs) 285	EST6036ESD Wgt (lbs) 285
EST7230 72"L x 30"W	EST7230HDPE Wgt (lbs) 341	EST7230ESD Wgt (lbs) 341
EST7236 72"L x 36"W	EST7236HDPE Wgt (lbs) 361	EST7236ESD Wgt (lbs) 361



Perfect for grinding or soldering

Option can be mounted on any base model

The **EST Model** station is designed to be connected to your "inhouse" exhaust system. Shown with the HDPE surface perforated on 1" centers with catch pan below with 4" diameter connection pipe on the bottom. Built on the MVSII electric height adjustable station with programmable memory and featuring the ET-1 electric tilt.

WELDING TABLES



PART NO.	.250 STEEL WORK SURFACE	Wgt. (lbs)
W/HD/ST4830	48"L x 30"W	135
W/HD/ST4836	48"L x 36"W	155
W/HD/ST6030	60"L x 30"W	165
W/HD/ST6036	60"L x 36"W	190
W/HD/ST7230	72"L x 30"W	195
W/HD/ST7236	72"L x 36"W	225
W/HD/ST9630	96"L x 30"W	250
W/HD/ST9636	96"L x 36"W	290

48"H STEEL BACKSTOP WITH UPRIGHTS
WST48 48"L Wgt (lbs) 135
WST60 60"L Wgt (lbs) 155
WST72 72"L Wgt (lbs) 175
WST96 96"L Wgt (lbs) 224

96" Long station shown with 6 leg design
Stations up to 72" long are 4 leg design

The **Model W/HD/ST** welding bench built on the Model HD frame has been in use since 1979. Unpainted .250" thick steel surface gives you a solid flat surface to weld on. Optional back stop blocks arc flash and helps contain spark. (Standard height 30" high)

SECTION II

PACKAGING / MAILROOM WORKSTATIONS

PACKAGING WORKSTATIONS

PACKAGING MAILROOM WORKSTATIONS



Proline's new Packaging Work Benches are sold complete with all accessories shown. Features include full lower shelf with four 18"x18" dividers, full width storage shelf with 4" of clearance, UR72 uprights, bin holder, 6 outlet power supply, paper spool holder, enclosed metal shelf 12" deep with four 4" dividers, corrugated storage shelf with four 12"x18" dividers and a shop light with a T-8 ballast

ESD price includes a ground kit.
Bench height is adjustable from 30" to 36".
 750 lbs. capacity.

In Stock Light Gray only

For other colors, see Inside back cover.

Additional charges may apply

"In Stock and ready to ship within 5 business days."

"THE COMPLETE PACK BENCH"

BASE PART NO./SIZE	PLASTIC LAMINATE		E.S.D.		SOLID MAPLE	
CPB6030	CPB6030PL		CPB6030ESD		CPB6030SM	
60"Lx30"W	Wgt. lbs 325	Wgt. Cap 750	Wgt. lbs 325	Wgt. Cap 750	Wgt. lbs 362	Wgt. Cap 750
CPB7230	CPB7230PL		CPB7230ESD		CPB7230SM	
72"Lx30"W	Wgt. lbs 355	Wgt. Cap 750	Wgt. lbs 355	Wgt. Cap 750	Wgt. lbs 399	Wgt. Cap 750

ROTARY SHEAR CUTTER

For cutting all types of thick packing materials. Mounts to any station. Cutter slides left to right.



PART NO.	DESCRIPTION	Wgt. (lbs)	Wgt. (cap)
RSC36	For 5' Bench 51"L	11	N/A
RSC48	For 6' Bench 63" L	12	N/A
RSC60	For 8' Bench 75"L	15	N/A
RB	Replacement Blade	1	N/A

PACKAGING WORKSTATIONS

BASE PART NO./SIZE (Indicate Custom Height)	PLASTIC LAMINATE		E.S.D. LAMINATE		SOLID 1 1/4" MAPLE	
PB7230 "Hgt	PB7230PL		PB7230ESD		PB7230SM	
72"L x 30"W	Wgt. (lbs) 255	Wgt. (cap) 1000	Wgt. (lbs) 255	Wgt. (cap) 1000	Wgt. (lbs) 292	Wgt. (cap) 1000
PB7236 "Hgt	PB7236PL		PB7236ESD		PB7236SM	
72"L x 36"W	Wgt. (lbs) 265	Wgt. (cap) 1000	Wgt. (lbs) 265	Wgt. (cap) 1000	Wgt. (lbs) 309	Wgt. (cap) 1000



MODULAR ACCESSORIES INCLUDED IN PB SERIES

PART NO.	DESCRIPTION	Wgt. (lbs)
HDLE-6	6" Leg Extenders	8
UR60	Accessory Upright Supports	7
PSH72	Paper Spool Holder 72"	5.91
USPSH72	Under Surface Spool Holder	6.5
MA-1	Articulating Monitor Arm	19
PBAMS1272	Adjustable Metal Shelf	32.5
1212DIV	12" x 12" Steel Dividers	2
EMCS1272	Enclosed Metal Shelf	42
RSC36	Rotary Shear Cutter	11

ERGONOMIC HEIGHT ADJUSTABLE PACKAGING WORKSTATIONS

BASE PART NO./SIZE	PLASTIC LAMINATE	ESD LAMINATE	SOLID MAPLE
ELHCPB4830 48"L x 30"W	ELHCPB4830PL Wgt (lbs) 375	ELHCPB4830ESD Wgt (lbs) 375	ELHCPB4830SM Wgt (lbs) 399
ELHCPB4836 48"L x 36"W	ELHCPB4836PL Wgt (lbs) 400	ELHCPB4836ESD Wgt (lbs) 400	ELHCPB4836SM Wgt (lbs) 424
ELHCPB6030 60"L x 30"W	ELHCPB6030PL Wgt (lbs) 430	ELHCPB6030ESD Wgt (lbs) 430	ELHCPB6030SM Wgt (lbs) 467
ELHCPB6036 60"L x 36"W	ELHCPB6036PL Wgt (lbs) 435	ELHCPB6036ESD Wgt (lbs) 435	ELHCPB6036SM Wgt (lbs) 472
ELHCPB7230 72"L x 30"W	ELHCPB7230PL Wgt (lbs) 435	ELHCPB7230ESD Wgt (lbs) 435	ELHCPB7230SM Wgt (lbs) 482
ELHCPB7236 72"L x 36"W	ELHCPB7236PL Wgt (lbs) 455	ELHCPB7236ESD Wgt (lbs) 455	ELHCPB7236SM Wgt (lbs) 499

For Electric Height Adjustment, change prefix to ELHECPB

Pro-Line's PB Model Packaging Workstations can be purchased complete with all accessories shown or remove those accessories not necessary for your application. It's easy with our modular design. 1000 lbs. capacity.

Standard height 30" to 36".

SCALE STAND

Scale stands come complete with a plastic laminate worksurface and a set of HDLE-6 that makes unit adjustable from 24"H to 30"H.

PART NO.	DESCRIPTION	Wgt. (lbs)
SCS2424	Scale Stand 24"W x 24"L	46
SCS3030	Scale Stand 30"W x 30"L	65

CARDBOARD STORAGE STAND

Cardboard stand is 24"W x 36"L with 5 steel dividers 24"W x 24"H. Painted steel to match workstations.

PART NO.	DESCRIPTION	Wgt. (lbs)
CS2436	Cardboard Stand	75



The **ELHCPB** combines two great Pro-line products, the convenience of our complete packaging station and the sturdy ergonomic design of our four post height adjustable station. The ELHCPB comes complete with a lower shelf, four dividers, uprights, overhead light, power supply with mounting rail, corrugated storage shelf with four dividers, storage shelf with 4" back, bin holder and a paper spool holder. Station also comes complete with four post hand crank hydraulic height adjustment with 750 LB. capacity.

Standard adjustment 30" to 42"

(Optional push button electric adjustable available at additional charge)

PACKAGING WORK BENCH

BASE PART NO./SIZE	PLASTIC LAMINATE		SOLID 1¾" MAPLE	
P6030 60"L x 30"W	P6030PL		P6030SM	
	Wgt. (lbs) 210	Wgt. (cap) 1,000	Wgt. (lbs) 240	Wgt. (cap) 1,000
P6036 60"L x 36"W	P6036PL		P6036SM	
	Wgt. (lbs) 220	Wgt. (cap) 1,000	Wgt. (lbs) 257	Wgt. (cap) 1,000
P7230 72"L x 30"W	P7230PL		P7230SM	
	Wgt. (lbs) 225	Wgt. (cap) 1,000	Wgt. (lbs) 273	Wgt. (cap) 1,000
P7236 72"L x 36"W	P7236PL		P7236SM	
	Wgt. (lbs) 235	Wgt. (cap) 1,000	Wgt. (lbs) 257	Wgt. (cap) 1,000
P9630 96"L x 30"W	P9630PL		P9630SM	
	Wgt. (lbs) 293	Wgt. (cap) 1,000	Wgt. (lbs) 342	Wgt. (kgs) 1,000
P9636 96"L x 36"W	P9636PL		P9636SM	
	Wgt. (lbs) 303	Wgt. (cap) 1,000	Wgt. (lbs) 362	Wgt. (cap) 1,000

Pro-Line's Packaging Station comes complete with accessories shown. Paper Roll not included. 1000 lbs. capacity.

Dividers can be sold separately. Each at additional charge.

Standard Height 30" to 36".

Other Heights available at an additional charge



Steel drawers are no longer available. Now comes standard with MDS6

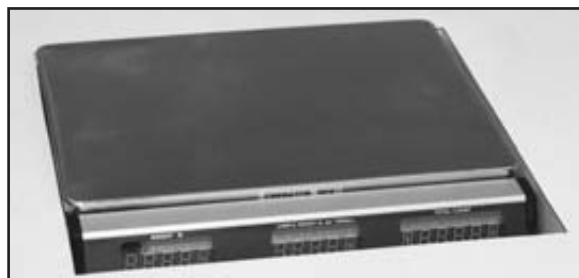

BUILT IN SCALE SHELF

Set your scale flush with your work surface. The built in scale shelf eliminates lifting products to weigh them—you just slide the product on the scale. Fits scales 12" x 12" x 2.65". For other sizes please consult factory. (Must be ordered at time of workstation purchase) 100 lbs. Capacity. Scale not included. **Please specify mounting location.**

PART NO.	DESCRIPTION	WGT. (LBS)
BISS1212	Scale Shelf 12.75" x 12.75" x 2.650"	10

PACK STAND

Free Standing packaging stand for easy handling and cutting of packaging material. Available as a single sided unit or a double sided unit. Shown as a double sided unit.

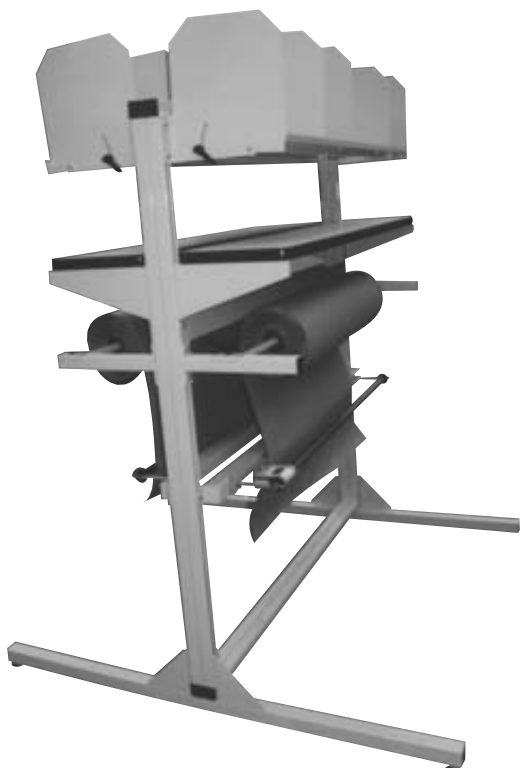

PART NO.	DESCRIPTION	Wgt. (lbs)
SPS6066	Single Sided 60"L x 66"H	106
DPS6066	Double Sided 60"L x 66"H	191

PAPER CUTTER

Holds 36"L rolls of paper

PART NO.	DESCRIPTION	Wgt. (lbs)
PHC36	38"L x 7"W x 8"H	5



MAIL ROOM SORTERS

Mount on any Basic Model

BASE WORKSTATIONS NOT INCLUDED

These versatile above-bench units provide an economical and efficient way to store, sort, and organize a variety of materials. Designed with flexibility and maximum space utilization in mind, these sturdy organizers are easily reconfigured as your needs change.

30-BIN HORIZONTAL SORTER

Shown in photo to left.

#ZS-6815-30, 68"L x 15"D x 18"H with enclosed back. Vertical separators welded in place. Order Dividers separately #ZSH-1511, 24 Dividers form 30 bin slots.

MODEL HD723030 SHOWN WITH 13" RISER AND HORIZONTAL SORTER



VERTICAL SORTER

#ZVS-6815, 68"W x 15"D x 18"H, 1.625" divider slot spacing. Order dividers separately #ZVD-15. Ideal for storing binders, repair manuals or catalogs.



30-BIN PASS THRU SORTER

#ZTS-6815-30, 68"W x 15"D x 18"H, open back design allows access from both sides. Vertical separators welded in place. Order dividers separately #ZTSH-1511, 24 dividers create 30 bin slots.

Horizontal Sorter shown with optional security doors. Order doors separately. #ZPLD-11. Clear plexiglass with lock. Secure 1, 2, up to 6 openings.

Doors must be ordered at time of sorter order (not field installable).



Example of how units stack —You create your own system!

PART NO.	DESCRIPTION	Wgt. (lbs)
ZS-6815-30	Horizontal Sorter 68"W x 15"D x 18"H	73
ZTS-6815-30	Pass Thru Sorter 68"W x 15"D x 18"H	77
ZVS-6815	Vertical Sorter 68"W x 15"D x 18"H	79
ZSH-1511	Horizontal Divider	1.6
ZVD-15	Vertical Divider	1.6
ZTSH-1511	Horizontal Pass thru Divide	1.6
ZR-6815-6	6" Closed Back Riser 68"L x 15"D x 6"H	28
ZR-6815-13	13" Closed Back Riser 68"L x 15"D x 13"H	38
ZTR-6815-6	6" Open Back Riser 68"L x 15"D x 6"H	22
ZTR-6815-13	13" Open Back Riser 68"L x 15"D x 13"H	29
ZPLD-11	Door (each door secures 1 opening)	2

SECTION III

L.A.N. / COMPUTER STATIONS

Proline offers several models of LAN stations. These stations are designed to meet all your LAN needs. Incorporating our modular design these stations are flexible, ergonomic and affordable.

The LNFL model is built on our FlexLine series. It is available in 24", 30" and 48" lengths. These units are easily bolted together to allow you to configure the ideal LAN station for your application. The part number LNFL includes an open frame 80" high, a 30" deep work surface and two horizontal and vertical leg supports. You add the accessories to meet your requirements. Work surface adjusts from 30" to 36".

L.A.N. COMPUTER STATIONS

PART NO.	PLASTIC LAMINATE		E.S.D.	
LNFL243080	LNFL243080PL		LNFL243080ESD	
24"Lx30"Wx80"H	Wgt. lbs 120	Wgt. Cap 750	Wgt. lbs 120	Wgt. Cap 750
LNFL303080	LNFL303080PL		LNFL303080ESD	
30"Lx30"Wx80"H	Wgt. lbs 128	Wgt. Cap 750	Wgt. lbs 128	Wgt. Cap 750
LNFL483080	LNFL483080PL		LNFL483080ESD	
48"Lx30"Wx80"H	Wgt. lbs 138	Wgt. Cap 750	Wgt. lbs 138	Wgt. Cap 750

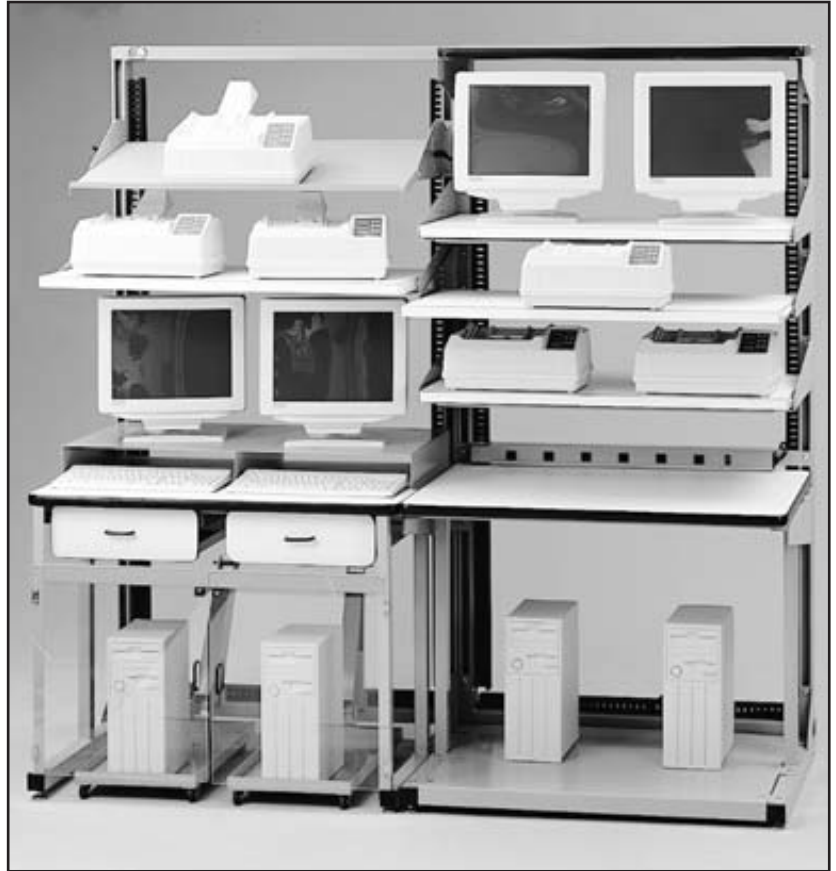

PART NO.	DESCRIPTION	WGT. (LBS)
WMS1.5	1.5"x1.5" Wire Management 72" long Specify length and and location at time of order	3
POPS2420F	Pull Out Printer Shelf 24"Lx20"D	20
POPS3020F	Pull Out Printer Shelf 30"Lx20"D	24
POPS4820F	Pull Out Printer Shelf 48"Lx20"D	28
MSR2420	Monitor Riser Shelf Steel 24"Lx20"D (single)	32
MSR3020	Monitor Riser Shelf Steel 30"Lx20"D (single)	38
MSR4820	Monitor Riser Shelf Steel 48"Lx20"D (double)	43
AMS2424FL	Adjustable Metal Shelf 24"Lx24"W Steel 90 Degree to 30 Degree	26
AMS3024FL	Adjustable Metal Shelf 30"Lx24"W Steel 90 Degree to 30 Degree	29
AMS4824FL	Adjustable Metal Shelf 48"Lx24"W Steel 90 Degree to 30 Degree	32
ESMR24FL	Electrical Supply Mounting Rail for 24"L flexline	1.75

PART NO.	DESCRIPTION	WGT. (LBS)
ESMR30FL	Electrical Supply Mounting Rail for 30" flexline	2.75
ESMR48FL	Electrical Supply Mounting Rail for 48" flexline	3.25
ES12	6 Outlet Power Supply Mounts to ESMR24 and 30	1.75
ES36	6 Outlet Power Supply Mounts to ESMR48	3.5
LNLS24FL	LAN Station Lower Shelf Steel. Includes three braces for heavy loads. 24"Lx30"D	24
LNLS30FL	LAN Station Lower Shelf Steel. Includes three braces for heavy loads. 30"Lx30"D	27
LNLS48FL	LAN Station Lower Shelf Steel. Includes three braces for heavy loads. 48"Lx30"D	30
PCPTF	Pull Out CPU Trays. Includes Articulating Wire Management 13 13/16" W x 23 7/8" L	32
PLGD	Plexiglass Doors. Protects CPU. Add 24, 30, 48 to part number to specify length.	23
MDS6	6" Modular Drawer	26

LNFL



LNFL

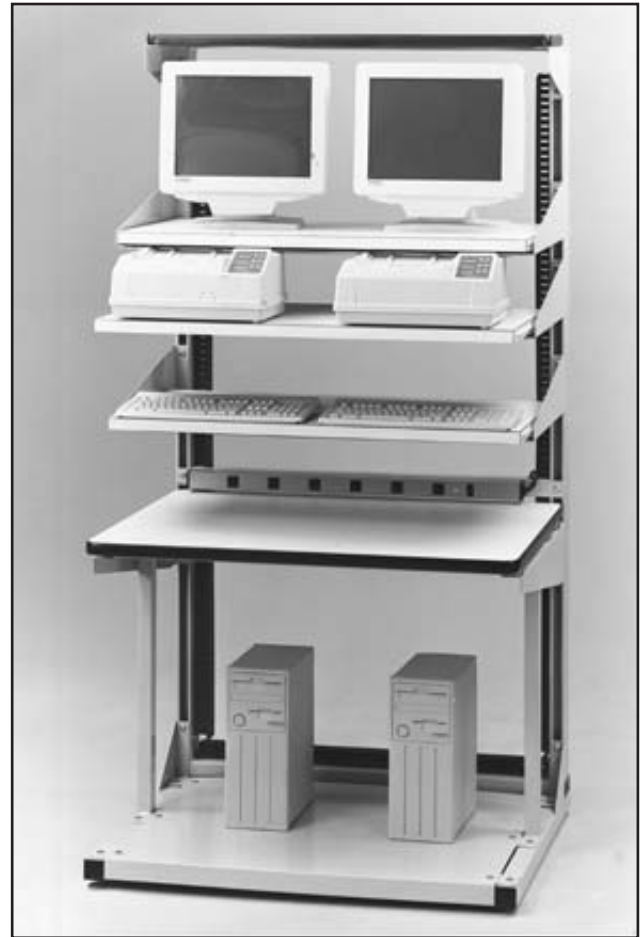

LNHD



LNHD

The LNHD is designed from our popular HD model. The model shown is 72"Lx30"Dx94"H to top of upright. Features on this model include a set of plate casters (two swivel with brake two rigid), full width lower shelf, three pull out keyboard trays, split upright system with four double uprights extending 60" above the surface and two cantilever shelves 18" deep x 72" long. With Pro-Line's modular design it's easy to configure the LAN station you need.

18" clearance from shelf to underside of keyboard tray.

Worksurface Height is 30"

PART NO.	PLASTIC LAMINATE		E.S.D.	
LNHD7230	LNHD7230PL		LNHD7230ESD	
72"Lx30"Wx94"H	Wgt. lbs 353	Wgt. Cap 1000	Wgt. lbs 353	Wgt. Cap 1000

COMPUTER TABLES

Pro-Line has taken our basic concept of a sturdy and economical design and incorporated it into these computer tables. The "CT" model is a cantilever design that is 48"L x 36"D x 30"H. Features include a steel modesty panel and a 90 degree rolled front edge. The "ECT" is an electric height adjustable computer station. With the smooth operating electric motor the unit quickly adjusts from 32" to 51.625" high. The "ECT" has a 250 pound capacity.

Base Part No./Size	PLASTIC LAMINATE		E.S.D.	
CT4836	CT4836PL		CT4836ESD	
48"Lx36"W	Wgt. lbs 110	Wgt. Cap 500	Wgt. lbs 110	Wgt. Cap 500
ECT3030	ECT3030PL		ECT3030ESD	
30"Lx30"W	Wgt. lbs 95	Wgt. Cap 250	Wgt. lbs 95	Wgt. Cap 250
ECT3636	ECT3636PL		ECT3636ESD	
36"Lx36"W	Wgt. lbs 115	Wgt. Cap 250	Wgt. lbs 115	Wgt. Cap 250



L. A. N. COMPUTER STATIONS

CPU HOLDER



Pull out and swivel CPU holder 75 lbs. capacity

PART NO.	DESCRIPTION	WGT. (LBS)
PRO-18785	Pull Out CPU Holder	9

Black finish with a 360° swivel.
Adjustable strap fits up to 65" perimeter.

**Mounts under any Pro-Line station.
Please specify model to be mounted
to when ordering**

FLAT SCREEN MONITOR ARM

See page 38



KEYBOARD TRAYS

Neatly and ergonomically store your keyboard. Both models slide under the work surface. Both models feature an adjustable clamp to fit any size keyboard. The "KBT" includes a black ABS plastic arm rest. The "DKBT" features a soft polyethylene foam pad with black vinyl upholstery. The "DKBT" is also height adjustable. The "KBT" has an optional mouse pad. The mouse pad for the "DKBT" adjusts with the keyboard.

OPTIONAL ACCESSORIES		
PART NO.	DESCRIPTION	WGT. (LBS)
KBT	Sliding Keyboard Tray with arm rest	6
MP	Mouse pad for the KBT	3
DKBT	Sliding Keyboard Tray with arm rest and height adjust	8
DMP	Mouse pad for the DKBT	3

**These keyboards can be mounted to all our models.
CPU and Keyboards include hanging kit.
(please specify for which model)**



SECTION IV

ACCESSORIES

NOTE: When ordering accessories only, please indicate the model they are mounting to.
Example: For a shelf with a Flexline Station use CSPL1260PL FL.

UPRIGHTS

Universal Uprights accept all accessories which would be suspended above work surface. Features infinite adjustability and self tightening hardware. Complete with mounting hardware. Priced per pair.

PART NO.	DESCRIPTION	Wgt. (lbs)
UR24	Uprights 24"/60.96cm (12" Above Surface)	8
UR36	Uprights 36"/91.44cm (24" Above Surface)	10
UR48	Uprights 48"/121.92cm (36" Above Surface)	15
UR60	Uprights 60"/152.40cm (48" Above Surface)	20
UR72	Uprights 72"/182.82cm (60" Above Surface)	25

UR 72 only are 3.25" Thick.
 All others 1.625" as shown



HEAVY DUTY UPRIGHTS

Constructed from the same material as our standard uprights, these uprights are double thick. Designed for placing heavy items on multiple shelves and mounting accessories behind station, chatter shields or a shelf, for example. HDUR60 are 60"L and extend up to 48" above surface. Sold in pairs.

PART NO.	DESCRIPTION	WGT. (LBS)
HDUR60	1.625" x 3.250" x 60" uprights extend 48" above surface.	40

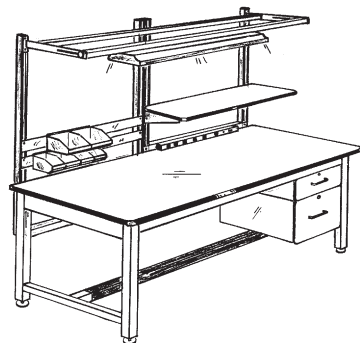

SPLIT UPRIGHT SYSTEM

Mounts to most Pro-Line Stations. Price includes 4 UR60 and 1 lower upright support. Extends 48" above surface.

PART NO.	DESCRIPTION	Wgt. (lbs)	Wgt. (cap)
SURS48	Split Upright System for 48" Bench	19.5	8.8
SURS60	Split Upright System for 60" Bench	20.5	9.3
SURS72	Split Upright System for 72" Bench	21.5	9.7
SURS96	Split Upright System for 96" Bench	25	11.3



ACCESSORIES

LOUVERED PANELS (FOR HANGING BINS)

These louvered panels are of steel construction. Panels are painted to match frame. 34" high.

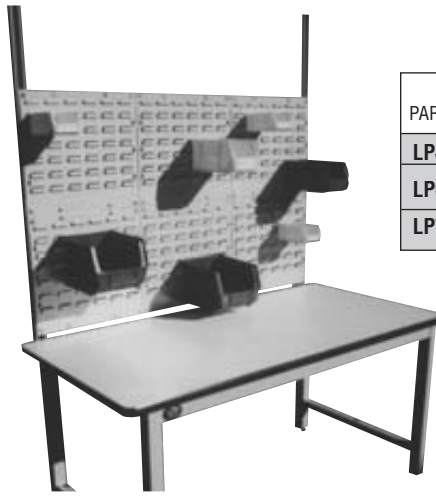

PART NO.	DESCRIPTION	Wgt. (lbs)	Wgt. (cap)
LP4834	Fits 48" Workstation	26	100
LP6034	Fits 60" Workstation	36	150
LP7234	Fits 72" Workstation	48	175

For other sizes,
Please consult factory

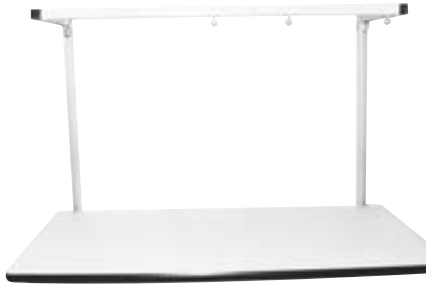

PART NO.	DESCRIPTION	Wgt. (lbs)	Wgt. (cap)
TSF1248	Tool Trolley Frame 12"W 48"L 30.48cm x 121.92cm Projection	12	75
TSF1260	Tool Trolley Frame 12"W 60"L 30.48cm x 152.40cm Projection	13	75
TSF1272	Tool Trolley Frame 12"W 72"L 30.48cm x 182.88cm Projection	14	75
TSF1296	Tool Trolley Frame 12"W 96"L 30.48cm x 243.84cm Projection	16	75

TOOL SUSPENSION FRAME I

Welded channel frame allows mounting of one or more tools with full length sliding capability. **(Not required if overhead light frame is purchased.)** Tool balancers and torque arms can then be utilized. Price includes 2 Tool Trolleys.



PART NO.	DESCRIPTION	Wgt. (lbs)	Wgt. (cap)
TSF1848	Tool Trolley Frame 18"W 48"L 45.76cm x 121.92cm Projection	13	75
TSF1860	Tool Trolley Frame 18"W 60"L 45.76cm x 152.40cm Projection	14	75
TSF1872	Tool Trolley Frame 18"W 72"L 45.76cm x 182.88cm Projection	15	75
TSF1896	Tool Trolley Frame 18"W 96"L 45.76cm x 243.84cm Projection	17	75

TOOL SUSPENSION FRAME II

This "Tool Suspension Frame" mounts directly into our "Overhead Light Frame." Tool balancers and torque arms can then be utilized. Tool Frame adjustable back and forward, full extension 24" over surface. Price includes 2 Tool Trolleys. **Extra Trolleys priced seperately. Part# ETT**

PART NO.	DESCRIPTION	Wgt. (lbs)	Wgt. (cap)
LTF48	Fits 48" Bench	12	75
LTF60	Fits 60" Bench	13	75
LTF72	Fits 72" Bench	14	75
LTF96	Fits 96" Bench	16	75

OVERHEAD LIGHT FRAME

Includes structural steel light mounting frame, (1) dual bulb fluorescent fixture with 9' powercord and on/off switch.

The new 3 way adjustable light allows adjustment of lighting front to back over worksurfaces as well as swivel capability. Comes complete with lock knobs. Rear support also functions as fixed tool balancer slide trolley.

OLF48 Comes standard with a T-8 Ballast, Optional on other lights

Center of light extrudes up to 24" from back of station. Bulbs not included.

For voltage requirements outside USA, additional charges apply. Please specify which country.

PART NO.	DESCRIPTION	Wgt. (lbs)	Wgt. (kgs)
OLF48	Mounts on 48"L/121.92cm Station	21	9.5
OLF60	Mounts on 60"L/152.40cm Station	27	12.2
OLF72	Mounts on 72"L/182.88cm Station	38	17.2
OLF96	Mounts on 96"L/243.84cm Station	45	20.4



STANDARD FIXTURE

ADDITIONAL CHARGE FOR DELUXE FIXTURE

ADD LETTER "D" TO PART# FOR DELUXE. ie:OLF60D



Parabolic lens available on deluxe fixture only, add "P" to part # ie: OLF60DP.

**Under shelf / Under cabinet lighting
Part# LT48...See page 57 for example**



Drawer Faces white only

FOOTREST

Heavy gauge steel painted to match frame – adds greater comfort and less fatigue for the operator. Shown with optional guard (priced on graph below).

PART NO.	DESCRIPTION	Wgt. (lbs)	Wgt. (kgs)
FR48	Fits 48"L/121.92cm Station	5	2.2
FR60	Fits 60"L/152.40cm Station	6¼	2.8
FR72	Fits 72"L/182.88cm Station	7½	3.4
FR96	Fits 96"L/243.84cm Station	10	4.5

FOOTREST GUARD

Black vinyl cover for the footrest is additional, adds comfort and enhanced appearance.

PART NO.	DESCRIPTION	Wgt. (lbs)	Wgt. (kgs)
FRG48	Rubber Guard for 48"L/121.92cm Station	4	1.8
FRG60	Rubber Guard for 60"L/152.40cm Station	5	2.2
FRG72	Rubber Guard for 72"L/182/99cm Station	6	2.7
FRG96	Rubber Guard for 96"L/243.84cm Station	8	3.6

MODULAR DRAWER SYSTEM (TOP QUALITY ROUNDED EDGE MODEL)

Features rounded T mold corners to match top for operator protection at knee level. Modular concept allows independent design for easy configuration throughout plant. Durable steel body with quality T mold edged laminate face, smooth drawer action on roller bearings. Requires one mounting bracket per workstation. Dim. of Drawers 15"W x 19¼"D.

PRICE INCLUDES LOCK

When ordering drawers alone, please add model# as suffix Example: HK/EL. Different models require their own hanging kits.

PART NO.	DESCRIPTION	Wgt. (lbs)	Wgt. (kgs)
MDS-3	3"H/7.62cm Drawer Unit	20	9
MDS-6	6"H/16.24cm Drawer Unit	26	11.8
MDS-9	9"H/22.86cm Drawer Unit	32	14.5
MDS-12	12"H/30.48cm Drawer Unit	38	17.2
HK	Drawer Hanging Kit	1.15	.52

HK also required on POWS, KOS, DP-1, and CPU.

20 AMP ELECTRICAL SUPPLY (20A, 125V)

Includes (3) or (5) duplex outlets, standard on/off switch, indicator light, resettable circuit breaker and 6' cord. Mounting is identical to our standard electrical supply.

NOTE: Other 20 amp configurations available upon request.

PART NO.	DESCRIPTION	Wgt. (lbs)	Wgt. (kgs)
ES36/20	20 AMP Electrical Supply 36"L/50.80cm x 91.44cm	4¼	1.9
ES48/20	20 AMP Electrical Supply 48"L/50.80cm x 121.96cm	5¼	2.3

STANDARD ELECTRICAL SUPPLY (15A, 125V)

Includes 12 outlets, on/off switch, on indicator light, resettable circuit breaker, 6' cord, mounts to electrical supply mounting rail (which is fully adjustable on uprights) or to worksurfaces, frame, etc. Electrical supplies punched and wired directly into the workstation frame are available upon request.

NOTE: Pro-Line can match any electrical or other utility specifications you may have.



For 48" Long Stations Use ES36

PART NO.	DESCRIPTION	Wgt. (lbs)	Wgt. (kgs)
ES12	12"L/30.48cm (6) Outlet Powerstrip	1¼	.8
ES36	36"L/91.44cm (9) Outlet Powerstrip	3½	1.5
ES48	48"L/121.92cm (12) Outlet Powerstrip	4½	2

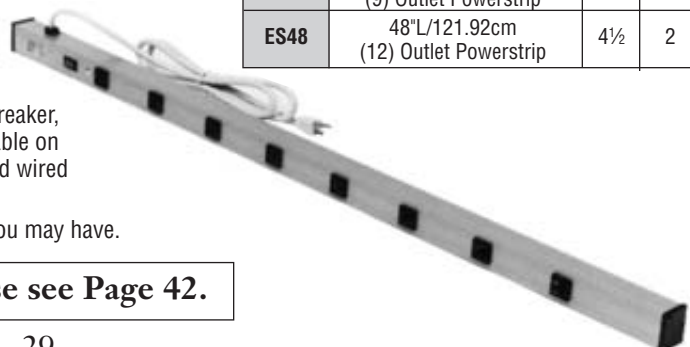

For voltage requirements outside USA, please see Page 42.

ELECTRICAL SUPPLY MOUNTING RAIL

Heavy gauge formed steel allows electrical supply to mount to upright system. 2 knockouts allow airquick disconnect to be added.

PART NO.	DESCRIPTION	Wgt. (lbs)	Wgt. (kgs)
ESMR24	Fits 24"/60.96cm Upright System	1¼	.8
ESMR30	Fits 30"/76.20cm Upright System	2¾	1.2
ESMR36	Fits 36"/91.44cm Upright System	3	1.3
ESMR48	Fits 48"/121.92cm Upright System	3¾	1.4
ESMR60	Fits 60"/152.40cm Upright System	4	1.8
ESMR72	Fits 72"/182.88cm Upright System	5	2.2
ESMR96	Fits 96"/243.84cm Upright System	7	3.1



AIRQUICK DISCONNECT

These air fittings easily mount into receptacle at either end of electrical supply mounting rail. Easily accessible yet keeps worksurface clear of hoses when pneumatic tools are in use.

PART NO.	DESCRIPTION	Wgt. (lbs)	Wgt. (kgs)
AQDC	Mounts on ESMR	1½	.6

LEG EXTENDERS

Formed steel channel sleeves into bottom of each leg to adjust height in 1" increments. Standard size allows 6" of adjustment. **Set of 4.**

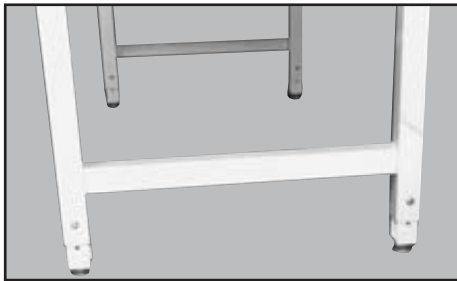

PART NO.	DESCRIPTION	Wgt. (lbs)	Wgt. (kgs)
HDLE-6	6"/15.24cm Leg Adjusters	8	3.6



TOOL BALANCER HOLDER

Mounts to any vertical upright. Channel construction allows tool hook to slide front to back. Standard sizes: TH8" – TH12" – TH18".

Tool balancer hooks onto tool hook.

PART NO.	DESCRIPTION	Wgt. (lbs)	Wgt. (kgs)
TH-8	Mounts to Uprights 8"/20.32cm Projection	2	9.55
TH-12	Mounts to Uprights 12"/30.48cm Projection	3	14.09
TH-18	Mounts to Uprights 18"/45.72cm Projection	4	18.64



BACK GUARD

3" H guard prevents items from rolling off back of worksurface.

PART NO.	DESCRIPTION	Wgt. (lbs)	Wgt. (kgs)
BSS48	Mounts on Surface 48"L/121.92cm	4½	2
BSS60	Mounts on Surface 60"L/152.40cm	5¾	2.6
BSS72	Mounts on Surface 72"L/182.88cm	7	3.1
BSS96	Mounts on Surface 96"L/243.84cm	9½	4.5

END GUARD

3"H guard prevents items from rolling off ends of worksurface. Priced per pair.

PART NO.	DESCRIPTION	Wgt. (lbs)	Wgt. (kgs)
ESS24	Mounts on Surface 24"W/60.96cm	2¼	1
ESS30	Mounts on Surface 30"W/76.20cm	3	1.3
ESS36	Mounts on Surface 36"W/91.44cm	3½	1.5



WIRE SPOOL HOLDER

1" diameter rod holds wire or packaging dispenser spools. Adjustable front to rear

PART NO.	DESCRIPTION	Wgt. (lbs)	Wgt. (kgs)
WSH48	Hold Wire Spool Reels 48"L/121.92cm	11	5
WSH60	Holds Wire Spool Reels 60"L/152.40cm	12	5.45
WSH72	Holds Wire Spool Reels 72"L/182.88cm	13	5.91
WSH96	Holds Wire Spool Reels 96"L/243.84cm	15	6.82



SLIDING DOOR CABINET

Sliding Door Cabinets are 14.5" x 13.75" ID. Cabinets come complete with a lock and mounting brackets. They are ideal for manual storage, components, or personal storage. 200 LB. capacity

PART NO.	DESCRIPTION	Wgt. (lbs)
SDC48	Sliding Door Cabinet 48"L	64
SDC60	Sliding Door Cabinet 60"L	80
SDC72	Sliding Door Cabinet 72"L	72



Standard Cabinet supplied with sliding steel doors. Also available with Lexan® sliding doors, glass doors or steel flipper doors

LAZY SUSAN

18" diameter, 4 position turntable for a wide variety of applications. Other sizes available upon request. 200 lbs capacity. **Min. order 3 units.** 2.53" H.

PART NO.	DESCRIPTION	Wgt. (lbs)	Wgt. (kgs)
LS18-16	Plastic Laminated Turntable 18" Diameter	12	5.45

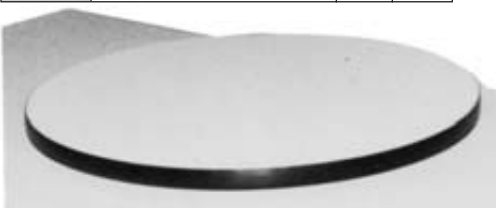

PURSE HOLDER

Open back and front storage when security is not required.

PART NO.	DESCRIPTION	Wgt. (lbs)	Wgt. (kgs)
PHB-1	10"W x 18"D x 12"H (Steel) 25.40cm x 45.72cm x 30.48cm	13	5.91

PURSE HOLDER WITH BACK

Same as above, with back

PART NO.	DESCRIPTION	Wgt. (lbs)	Wgt. (kgs)
PHB-2	10"W x 18"D x 12"H (Steel) 25.40cm x 45.72cm x 30.48cm	15.5	7.05



Note:
SDC should be mounted with back to back HDUR. See page 27 or UA72

BIN HOLDER

Heavy gauge formed steel mounts to upright system for unlimited adjustment of bins

PART NO.	DESCRIPTION	Wgt. (lbs)	Wgt. (kgs)
BH24	Fits 24"/60.96cm Upright System	2¼	.8
BH30	Fits 30"/76.20cm Upright System	2½	1.1
BH36	Fits 36"/91.44cm Upright System	3½	1.5
BH48	Fits 48"/121.92cm Upright System	4½	2
BH60	Fits 60"/152.40cm Upright System	5½	2.4
BH72	Fits 72"/182.88cm Upright System	6½	2.8
BH96	Fits 96"/243.84cm Upright System	7½	3.2

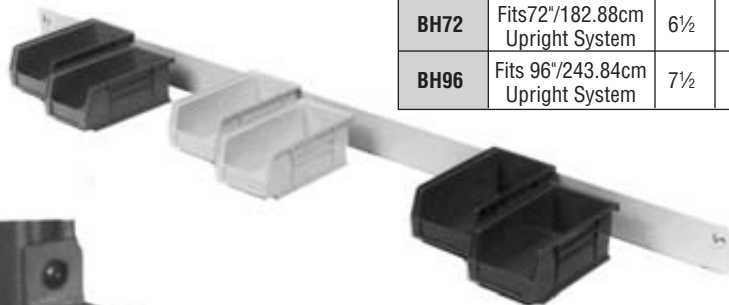

MAGNIFIER LIGHT BRACKET

Bracket mounts to upright at any height for mounting of magnification lights, document holders, etc.

PART NO.	DESCRIPTION	Wgt. (lbs)	Wgt. (kgs)
LOMB	Mounts to Uprights	1	.4

MODESTY PANEL (STEEL)

Steel panel painted to match frame. Encloses rear of workstation. 21"H

PART NO.	DESCRIPTION	Wgt. (lbs)	Wgt. (kgs)
MP48	Mounts on 48"L/121.92cm Station	19	8.6
MP60	Mounts on 60"L/152.40cm Station	23½	10.6
MP72	Mounts on 72"L/182.88cm Station	28	12.7
MP96	Mounts on 96"L/243.84cm Station	37½	43.6



MODESTY PANEL (PLASTIC LAMINATE)

Modesty Panel plastic laminate. Encloses rear of frame. 21"H

PART NO.	DESCRIPTION	Wgt. (lbs)	Wgt. (kgs)
MPP48	Mounts on 48"L/121.92cm Station	15	6.8
MPP60	Mounts on 60"L/152.40cm Station	18¾	8.5
MPP72	Mounts on 72"L/182.88cm Station	22½	10.2
MPP96	Mounts on 96"L/243.84cm Station	30	13.6



END PANEL (STEEL)

Steel panel painted to match frame. Encloses one or both ends of workstation. Priced each.

PART NO.	DESCRIPTION	Wgt. (lbs)	Wgt. (kgs)
EP24	Mounts on 24"W/60.96cm Station	11	5
EP30	Mounts on 30"W/76.20cm Station	14	6.3
EP36	Mounts on 36"W/91.44cm Station	17	7.7



END PANEL (PLASTIC LAMINATE)

End Panel plastic laminate. Encloses one or both ends of workstation. Priced each.

PART NO.	DESCRIPTION	Wgt. (lbs)	Wgt. (kgs)
EPP24	Mounts on 24"W/60.96cm Station	10	4.5
EPP30	Mounts on 30"W/76.20cm Station	12½	5.6
EPP36	Mounts on 36"W/91.44cm Station	15	6.8



CANTILEVER SHELF (PLASTIC LAMINATE)

Includes (1) 12" or 18" wide plastic laminate shelf and shelf supports for each upright – infinitely adjustable. 125 lb capacity per shelf.

BASE PART NO./SIZE	PLASTIC LAMINATE		E.S.D. LAMINATE		SOLID 1¼" MAPLE	
	Wgt. (lbs)	Wgt. (kgs)	Wgt. (lbs)	Wgt. (kgs)	Wgt. (lbs)	Wgt. (kgs)
CSPL1224 12" x 24" (30.4cm x 60.7cm)	CSPL1224PL		CSPL1224ESD		CSPL1224SM	
	12	5.4	12	5.4	12	5.4
CSPL1230 12" x 30" (30.4cm x 76.2cm)	CSPL1230PL		CSPL1230ESD		CSPL1230SM	
	15	6.8	15	6.8	15	6.8
CSPL1236 12" x 36" (30.4cm x 91.4cm)	CSPL1236PL		CSPL1236ESD		CSPL1236SM	
	18	8.1	18	8.1	18	8.1
CSPL1248 12" x 48" (30.4cm x 121.9cm)	CSPL1248PL		CSPL1248ESD		CSPL1248SM	
	24	10.9	24	10.9	24	10.9
CSPL1260 12" x 60" (30.4cm x 152.4cm)	CSPL1260PL		CSPL1260ESD		CSPL1260SM	
	30	13.6	30	13.6	30	13.6
CSPL1272 12" x 72" (30.4cm x 182.8cm)	CSPL1272PL		CSPL1272ESD		CSPL1272SM	
	36	16.3	36	16.3	36	16.3
CSPL1296 12" x 96" (30.4cm x 243.8cm)	CSPL1296PL		CSPL1296ESD		CSPL1296SM	
	42	19	42	19	42	19
CSPL1824 18" x 24" (45.7cm x 76.2cm)	CSPL1824PL		CSPL1824ESD			
	17	7.6	17	7.6		
CSPL1830 18" x 30" (45.7cm x 76.2cm)	CSPL1830PL		CSPL1830ESD			
	22	10.1	22	10.1		
CSPL1836 18" x 36" (45.7cm x 91.4cm)	CSPL1836PL		CSPL1836ESD			
	26	11.9	26	11.9		
CSPL1848 18" x 48" (45.7cm x 121.9cm)	CSPL1848PL		CSPL1848ESD			
	31	13.9	31	13.9		
CSPL1860 18" x 60" (45.7cm x 152cm)	CSPL1860PL		CSPL1860ESD			
	35	16	35	16		
CSPL1872 18" x 72" (45.7 x 182.8cm)	CSPL1872PL		CSPL1872ESD			
	40	18	40	18		
CSPL1896 18" x 96" (45.7cm x 243.8cm)	CSPL1896PL		CSPL1896ESD			
	44	20.1	44	20.1		

PLEASE CONSULT THE FACTORY FOR ALL YOUR CUSTOM FABRICATION REQUIREMENTS

PLEASE NOTE:

When ordering accessories, the model number that the accessory is mounting to must be indicated.

Example: A shelf mounting to a FlexLine station would use a part #CSPL1260PLFL for the 60".



ACCESSORIES

ADJUSTABLE METAL SHELF

Rigid steel shelf painted to match frame. Easily adjusts from flat to 30° incline position.

PART NO.	DESCRIPTION	Wgt. (lbs)	Wgt. (cap)
AMS1224	24"W x 12"D	10	70
AMS1230	30"W x 12"D	12.5	70
AMS1236	36"W x 12"D	15	70
AMS1248	48"W x 12"D	22.25	75
AMS1260	60"W x 12"D	27.25	95
AMS1272	72"W x 12"D	32½	105
AMS1824	24"W x 18"D	15	70
AMS1830	30"W x 18"D	17.5	70
AMS1836	36"W x 18"D	20	70
AMS1848	48"W x 18"D	29.25	75
AMS1860	60"W x 18"D	35.00	95
AMS1872	72"W x 18"D	41	105



13/16" Front Lip retains items

WIRE CANTILEVER SHELF

(1) bright zinc plated wire form shelf – (2) shelf support gussets – mounting at any height. Very economical approach.

PART NO.	DESCRIPTION	Wgt. (lbs)
WCS12-24	12"W/30.48cm x 60.96cm Fits 24" Upright System	5
WCS12-30	12"W/30.48cm x 76.20cm Fits 30" Upright System	6
WCS12-36	12"W/30.48cm x 91.44cm Fits 36" Upright System	7
WCS12-48	12"W/30.48cm x 121.92cm Fits 48" Upright System	9½
WCS12-60	12"W/30.48cm x 152.40cm Fits 60" Upright System	12
WCS12-72	12"W/30.48cm x 182.88cm Fits 72" Upright System	15

PART NO.	DESCRIPTION	Wgt. (lbs)
WCS18-24	18"W/45.72cm x 60.96cm Fits 24" Upright System	6½
WCS18-30	18"W/45.72cm x 76.20cm Fits 30" Upright System	8
WCS18-36	18"W/45.72cm x 91.44cm Fits 36" Upright System	10
WCS18-48	18"W/45.72cm x 121.92cm Fits 48" Upright System	12½
WCS18-60	18"W/45.72cm x 152.40cm Fits 60" Upright System	16
WCS18-72	18"W/45.72cm x 182.88cm Fits 72" Upright System	21

PART NO.	DESCRIPTION	Wgt. (lbs)
SWCS12-24	Slanted 12" W Fits 24" Upright Sys./30.48cm x 60.96cm	6
SWCS12-30	Slanted 12" W Fits 30" Upright Sys./30.48cm x 72.20cm	7
SWCS12-36	Slanted 12" W Fits 36" Upright Sys./30.48cm x 91.44cm	8
SWCS12-48	Slanted 12" W Fits 48" Upright Sys./30.48cm x 121.92cm	10
SWCS12-60	Slanted 12" W Fits 60" Upright Sys./30.48cm x 152.40cm	14
SWCS12-72	Slanted 12" W Fits 72" Upright Sys./30.48cm x 182.88cm	16

PART NO.	DESCRIPTION	Wgt. (lbs)
SWCS18-24	Slanted 18" W Fits 24" Upright Sys./45.72cm x 60.96cm	8
SWCS18-30	Slanted 18" W Fits 30" Upright Sys./45.72cm x 76.20cm	10
SWCS18-36	Slanted 18" W Fits 36" Upright Sys./45.72cm x 91.44cm	12
SWCS18-48	Slanted 18" W Fits 48" Upright Sys./45.72cm x 121.92cm	14
SWCS18-60	Slanted 18" W Fits 60" Upright Sys./45.72cm x 152.40cm	17
SWCS18-72	Slanted 18" W Fits 72" Upright Sys./45.72cm x 182.88cm	23

SLANTED WIRE SHELF

Same as WCS but set at slant 15°.

PULL OUT WRITING SHELF

Steel writing surface 12"W x 18"D. 30 lbs. capacity.

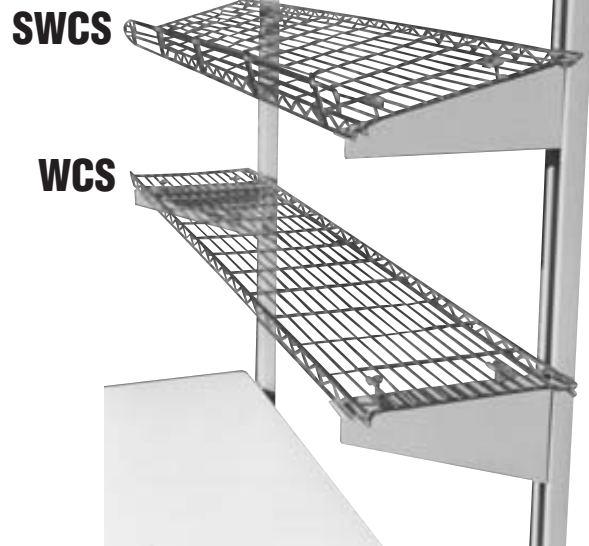

PART NO.	DESCRIPTION	Wgt. (lbs)	Wgt. (kgs)
POWS	Pull Out Shelf 12"W x 18"D 30.48cm x 45.72cm	12	5.45

Note: Both POWS and KOS require one HK Hanging Kit. Additional charge applies

PULL OUT KEYBOARD

Powder coat painted steel

PART NO.	DESCRIPTION	Wgt. (lbs)	Wgt. (kgs)
KOS	Pull Out Keyboard Shelf 12"D x 19¾"L x 2.5 Clearance	16	7.2



STANDARD LOWER SHELF

Heavy gauge formed shelf painted to match frame – 12" wide with a load capacity of 150 lbs.

Actual Depth 12"		Wgt.	Wgt.
PART NO.	DESCRIPTION	(lbs)	(kgs)
HDLS48-12	12"W Fits 48"L Unit 30.48cm x 121.92 cm	15	6.8
HDLS60-12	12"W Fits 60"L Unit 30.48cm x 152.40 cm	18¾	8.5
HDLS72-12	12"W Fits 72"L Unit 30.48cm x 182.88 cm	22½	10.2
HDLS96-12	12"W Fits 96"L Unit 30.48cm x 243.84 cm	30	13.6

Actual Depth 18"		Wgt.	Wgt.
PART NO.	DESCRIPTION	(lbs)	(kgs)
HDLS48-18	18"W Fits 48"L Unit 45.72cm x 121.92 cm	20	9
HDLS60-18	18"W Fits 60"L Unit 45.72cm x 152.40 cm	25	11.3
HDLS72-18	18"W Fits 72"L Unit 45.72cm x 182.88 cm	30	13.6
HDLS96-18	18"W Fits 96"L Unit 45.72cm x 243.84 cm	40	18.1



PART NO.	DESCRIPTION	Wgt.	Wgt.
		(lbs)	(kgs)
TIS1248	12"W x 48"L x 15"H 30.48cm x 121.92cm x 38.10cm	34	15.45
TIS1260	12"W x 60"L x 15"H 30.48cm x 152.40cm x 38.10cm	40½	18.41
TIS1272	12"W x 72"L x 15"H 30.48cm x 182.88cm x 38.10cm	47	21.36
TIS1296	12"W x 96"L x 15"H 30.48cm x 243.84cm x 38.10cm	60	27.27

PART NO.	DESCRIPTION	Wgt.	Wgt.
		(lbs)	(kgs)
TIS1848	18"W x 48"L x 15"H 45.72cm x 121.92cm x 38.10cm	38	17.27
TIS1860	18"W x 60"L x 15"H 45.72cm x 152.40cm x 38.10cm	44½	20.23
TIS1872	18"W x 72"L x 15"H 45.72cm x 182.88cm x 38.10cm	51	23.18
TIS1896	18"W x 96"L x 15"H 45.72cm x 243.84cm x 38.10cm	64	29.09

FULL WIDTH LOWER SHELF

Steel painted to match frame, mounts at lower level.

Actual Depth 17.25"		Wgt.	Wgt.
PART NO.	DESCRIPTION	(lbs)	(kgs)
FWLS48-24	24"W Fits 48"L Unit 60.96cm x 121.92 cm	25	11.3
FWLS60-24	24"W Fits 60"L Unit 60.96cm x 152.40 cm	31¼	14.2
FWLS72-24	24"W Fits 72"L Unit 60.96cm x 182.88 cm	37½	17
FWLS96-24	24"W Fits 96"L Unit 60.96cm x 243.84 cm	50	22.7

Actual Depth 23.25"		Wgt.	Wgt.
PART NO.	DESCRIPTION	(lbs)	(kgs)
FWLS48-30	30"W Fits 48"L Unit 76.20cm x 121.92 cm	30	13.6
FWLS60-30	30"W Fits 60"L Unit 76.20cm x 152.40 cm	37½	17
FWLS72-30	30"W Fits 72"L Unit 76.20cm x 182.88 cm	45	20.4
FWLS96-30	30"W Fits 96"L Unit 76.20cm x 243.84 cm	60	27.2

Actual Depth 29.25"		Wgt.	Wgt.
PART NO.	DESCRIPTION	(lbs)	(kgs)
FWLS48-36	36"W Fits 48"L Unit 91.44cm x 121.92 cm	35	15.9
FWLS60-36	36"W Fits 60"L Unit 91.44cm x 152.40 cm	43¾	19.8
FWLS72-36	36"W Fits 72"L Unit 91.44cm x 182.88 cm	52½	23.8
FWLS96-36	36"W Fits 96"L Unit 91.44cm x 243.84 cm	70	31.8



TUBULAR INSTRUMENT SHELF

T mold plastic laminate shelf supported with heavy duty tubular steel frame.

Other heights available at an additional charge



BINS

Proline offers a wide variety of bins and containers that are available in both standard and conductive. All have a common feature: they can be easily put on and taken off our bin holders and our louvered panels. **Sold in Cartons Only.** Standard Bin Colors: Blue, Red, Yellow, Ivory. Conductive Bins Black Only.

Standard Bins

Part No.	Length	Width	Height	Capacity	Carton Qty.	Carton Wgt.
BN-205	4.5"	4.125"	3"	8	24	5
BN-210	5.5"	4.125"	3"	8	24	6
BN-220	7.5"	4.125"	3"	8	24	6
BN-230	11"	5.5"	5"	20	12	11
BN-233	13.5"	5.5"	5"	20	12	13
BN-235	11"	11"	5"	50	6	11
BN-239	11"	8.25"	7"	50	6	11
BN-240	14.750"	8.250"	7"	50	12	24
BN-250	14.750"	16.5"	7"	75	6	21
BN-255	16"	11"	8"	75	4	14
BN-260	18"	11"	10"	75	4	15
BN-270	18"	16.5"	11"	75	3	23



Conductive Bins

Part No.	Length	Width	Height	Capacity	Carton Qty.	Carton Wgt.
BN-205C	4.5"	4.125"	3"	8	24	5
BN-210C	5.5"	4.125"	3"	8	24	6
BN-220C	7.5"	4.125"	3"	8	24	7
BN-230C	11"	5.5"	5"	20	12	12
BN-233C	13.5"	5.5"	5"	20	12	14
BN-235C	11"	11"	5"	50	6	15
BN-239C	11"	8.25"	7"	50	6	11
BN-240C	14.750"	8.250"	7"	50	12	25
BN-250C	14.750"	16.5"	7"	75	6	22
BN-255C	16"	11"	8"	75	4	15
BN-260C	18"	11"	10"	75	4	16
BN-270C	18"	16.5"	11"	75	3	18

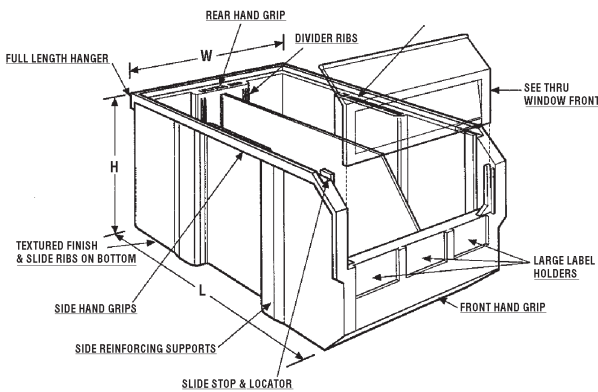
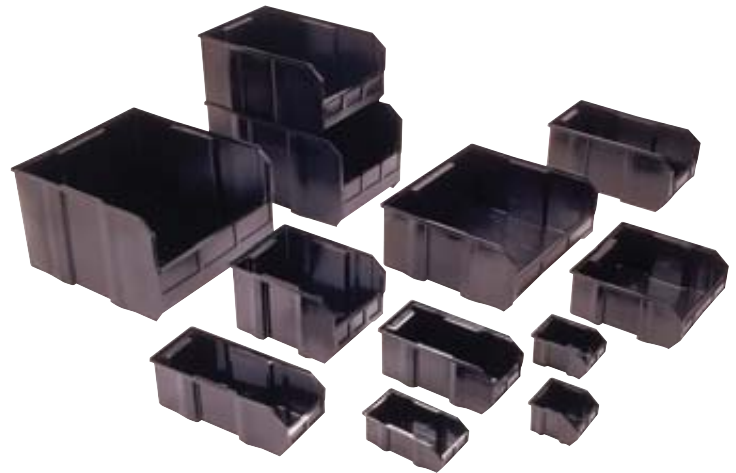

ACCESSORIES



0° - 30° WORK SURFACE TILT MECHANISM

Add to base price of station.

Often a tilted work surface allows operators to reduce lower back and arm fatigue. A front lip on the work surface keeps work in process on the table.

Electric Tilt – activated by push button or pedal.

Hydraulic Tilt – activated by hand crank

Mechanical Tilt – activated by lifting surface manually (13 positions)

Tilt option must be purchased with initial bench order.

PART NO.	DESCRIPTION	Wgt. (lbs)	Wgt. (cap)
ET-1	Electric Tilt	42	400
HT-1	Hydraulic Tilt	49	300
MT-1	Mechanical Tilt	25	75

CORKBOARD TACK BOARD

Tack Board Corkboard Front with white plastic laminate rear. T mold edges for clean finish look includes supports. Mounts to uprights.

PART NO.	DESCRIPTION	Wgt. (lbs)	Wgt. (cap)
TB24	24" x 12"	5.75	2.6
TB30	30" x 12"	7.25	3.3
TB36	36" x 12"	8	3.6
TB48	48" x 12"	9.25	4.2
TB60	60" x 12"	11	5
TB72	72" x 12"	13	5.9
TB96	96" x 12"	17	7.7



SOLDER SPOOL HOLDER

Fits standard solder rolls. Also mounts onto Bin Holders.

PART NO.	DESCRIPTION	Wgt. (lbs)	Wgt. (kgs)
SH-1	Solder Spool Holder	.5	.22

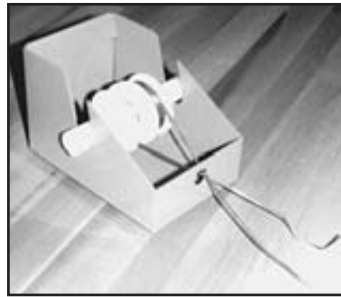

ARTICULATING BIN HOLDER

17"H x 18"W locks in 2 positions. Bins optional. Extends up to 23.5" from upright.

PART NO.	DESCRIPTION	Wgt. (lbs)	Wgt. (cap)
ABH-1	Articulating Bin Holder	19	60



PART NO.	DESCRIPTION	Wgt. (lbs)	Wgt. (cap)
DP-1	15"L x 12"W x 12"H	13	65
DP-HK	mounting bracket	1	



PAD LOCK DRAWER

Drawer with hasp for pad lock. Drawer features louvers for ventilation. Requires one **HK** mounting bracket per workstation. Part# **DP-HK**

FREE STANDING FOOTREST

Adjustable for different size operators from 3" to 11".

PART NO.	DESCRIPTION	Wgt. (lbs)	Wgt. (cap)
T-20	Free Standing Footrest 12" x 20"	10	150

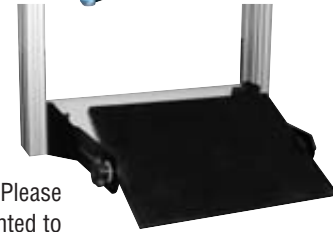
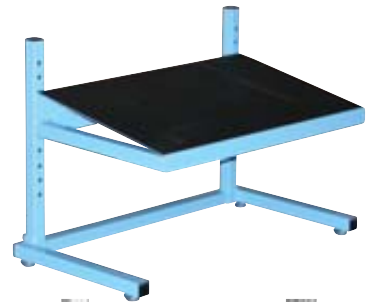

Suspends from bottom of frame Please specify model to be mounted to

Example: AT-20/HD **Attached Adjustable Footrest**

PART NO.	DESCRIPTION	Wgt. (lbs)	Wgt. (cap)
AT-20	Attached Footrest with 12" x 20" pan	35	75

ARTICULATING MONITOR ARM

With 14" x 14" platform. Platform rotates 360°. Price includes clip on keyboard tray and mounting bracket. Extends up to 27.5" from upright. Up to 40 lbs. **For higher capacity see page 41.**

PART NO.	DESCRIPTION	Wgt. (lbs)	Wgt. (cap)
MA-1	Monitor Arm	19	50



TORQUE ARM / BALANCER AND STAND

Eliminate torque when powered assembly tools are activated!

36" Swing boom pivots on 60" column above worksurface. Provides full coverage for 60" x 30" worksurface.

- Pneumatic tool not included!

PART NO.	DESCRIPTION	Wgt. (lbs)
TQ-1	Torque Arm/Balancer	31

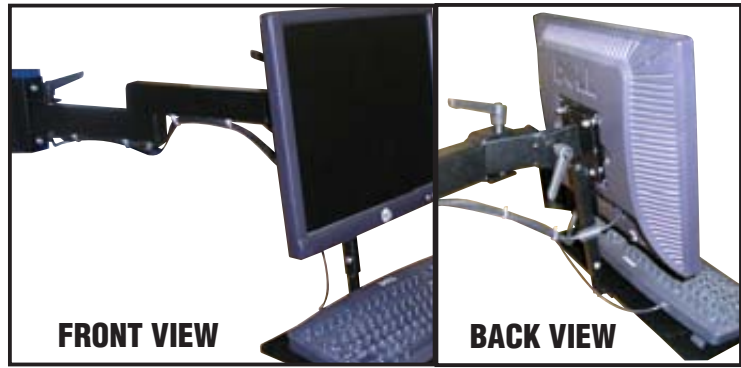

FSMA FLAT SCREEN MONITOR ARM*

75mm or 100mm Hole to Hole Mounting.

PART NO.	DESCRIPTION	Wgt. (lbs)
FSMA	Flat Screen Monitor Arm	21
FSMAKBT	Adjustable Keyboard Tray	11

*MONITOR AND KEYBOARD NOT INCLUDED

ACCESSORIES

TOOL BALANCER

Balance out assembly tools so they weigh next to nothing!

PART NO.	DESCRIPTION	Wgt. (lbs)
TB-1	For tools weighing up to 1 lb	6
TB-5	For tools weighing up to 5 lbs	6



3 DIOPTER INSPECTION LIGHT

Requires Lomb from page 31 to mount to accessory uprights. Standard color Black.

PART NO.	DESCRIPTION	Wgt. (lbs)	Wgt. (cap)
MAG1	3 Diopter/45" Arm	9	N/A



DOCUMENT HOLDER

Requires Lomb from page 31 to mount to accessory uprights.

PART NO.	DESCRIPTION	Wgt. (lbs)	Wgt. (cap)
DH-1	10" x 12" / 33" Reach	10	2



TOOL HOLDER

Sits on worksurface or hangs on bin holder.

PART NO.	DESCRIPTION	Wgt. (lbs)	Wgt. (cap)
TH-1	Tool Holder	.5	.22



UNDER SHELF PULL OUT KEYBOARD TRAY

Stores your keyboard under the shelf when not in use. Allows for more room on your work surface.

PART NO.	DESCRIPTION	Wgt. (lbs)
UPKT1248	12"D mounts to CSPL1248	12
UPKT1260	12"D mounts to CSPL1260	20
UPKT1272	12"D mounts to CSPL1272	32



PIVOTING TOOL HOLDER

Mounts to our vertical uprights. Allows tool to be pivoted over work surface. Available in 18" and 24" lengths.

PART NO.	DESCRIPTION	Wgt. (lbs)
PTH18	Extends 18" from upright	4.5
PTH24	Extends 24" from upright	5.5

BUILT IN LAZY SUSAN

Fits flush mount in any basic workstation. 18" diameter.

PART NO.	DESCRIPTION	Wgt. (lbs)	Wgt. (kgs)
LZ-1	Flush Mount Lazy Susan 18" Diameter	21	200

Must be ordered with initial purchase.

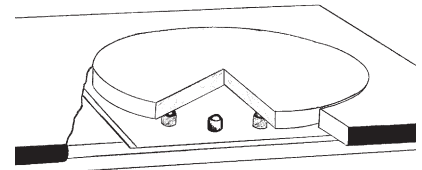

CONVEYOR PALLETS

Custom sizes available upon request.
For Standard Laminate add **PL** to Part #.
For **ESD** Laminate add **ESD** to Part #.

PART NO.	DESCRIPTION	Wgt. (lbs)	Wgt. (cap)	Plastic Laminate	ESD Laminate
CP1824	18" x 24" x 3/4"	9	250	CP1824PL	CP1824ESD
CP2424	24" x 24" x 3/4"	12	250	CP2424PL	CP2424ESD
CP1836	18" x 36" x 3/4"	13.5	250	CP1836PL	CP1836ESD

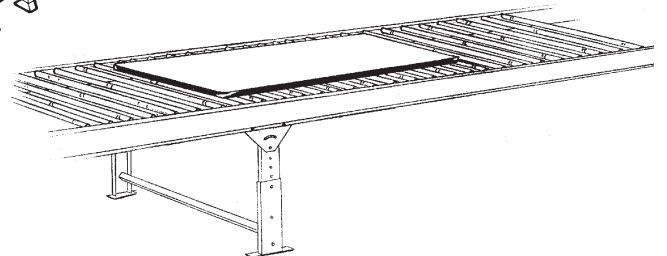
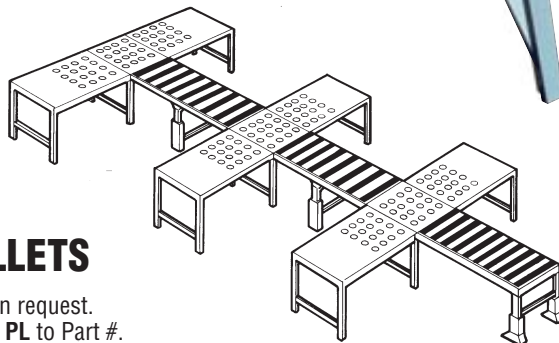

MAKE YOUR WORKSTATION MOBILE...

CASTERS TWO SWIVEL/TWO BRAKE

To mobilize workstations soft tread rubber caster. 3" diameter wheel.

PART NO.	DESCRIPTION	Wgt. (lbs)	Wgt. (cap)
C-4	Stem Casters (set of 4) All swivel 2 with brake	4	400
POC-4	Stem Casters (set of 4) with polypropelene wheels All swivel 2 with brakes	4	400



C-4



PC-4 Swivel

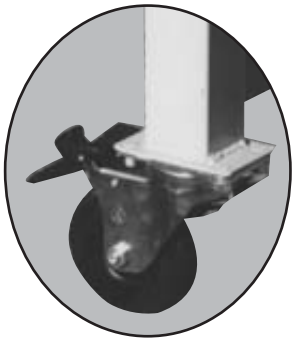

Total Lock

PART NO.	DESCRIPTION	Wgt. (lbs)	Wgt. (cap)
PC-4	Plate Casters 2 swivel with brake 2 rigid (set of 4)	5	400
TLC-4	Total Lock Casters a set of 4 casters locks both wheel and swivel. Plate style caster	6	400
ELH POC-4	For ELH Series only All Swivel	4	400

All Priced per set of four.

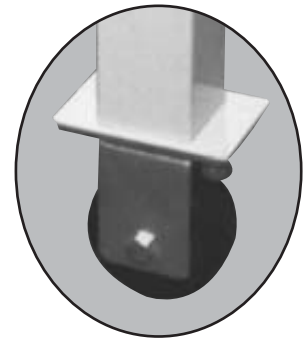

PC-4 Rigid

CASTER APPLICATIONS For Various Models

- C-4** Four leg workstations without leg extenders (can be added at any time) all four swivel. Models HD, TSHD, TW, PB, P, BT, GRBT. **Adds 2.75" to Height.**
- PC-4** Requires caster plates welded to station. Cantilever models, stations with HDLE-6, flexlines, 2 Swivel, 2 Rigid with brakes. **Adds 3.25" to Height.**
- TLC-4** Requires caster plates welded to station. All four have locks that locks both swivel and roll. Suggested uses EL, MVSII, and Modular cabinets. **Adds 4.25" to Height.**
- POC-4** Same as C-4 with polypropylene wheels.
- ELH/POC-4** For ELH Series, All swivel Additional charges apply.

PC-4, TLC-4 Must order at time of workstation purchase or they will require a mounting bracket that is available at an additional cost



— For E.S.D. and/or many other casters.

ACCESSORIES



DUAL AXIS TOOL SUSPENSION FRAME

Trolleys on this tool suspension frame travel on both axis left to right and forward to rear. Frame extends 30" from upright. Price includes one tool trolley. Shown with UR72.

(Unit shown with torque arm priced on next graph.)

PART NO.	DESCRIPTION	Wgt. (lbs)
DATSF48	30" Deep x 48" Long	12
DATSF60	30" Deep x 60" Long	15
DATSF72	30" Deep x 72" Long	18
DATSF96	30" Deep x 96" Long	25

TORQUE ARM

Torque Arm and Balancer to mount onto DATSF as shown. (DATSF sold separately.)

PART NO.	DESCRIPTION	Wgt. (lbs)
TQ-2	Torque Arm and Balancer for DATSF. Fits all length stations	5

STEEL PEG BOARD

Steel Peg Boards painted to match frame. Mounts to Pro-Line upright system.



HEAVY DUTY MONITOR ARM

Heavy Duty Monitor Arms feature a 14" x 14" platform. Used for monitors 40 lbs to 80 lbs.

PART NO.	DESCRIPTION	Wgt. (lbs)
HDMA-2	Heavy Duty Monitor Arm	24

PART NO.	DESCRIPTION	Wgt. (lbs)
SPB2448	24" High x 48" Long	8
SPB2460	24" High x 60" Long	10
SPB2472	24" High x 72" Long	12
SPB2496	24" High x 96" Long	16



WIRE MANAGEMENT SYSTEM

Shown in photograph mounted vertically to our upright system. This flexible system can also be mounted horizontally to our upright system. Available in both 1.5" sq. and 2" sq. (Black) Lead free PVC. Priced in 6' long sections. We will cut to fit application. Example: For two pieces 36" long you need one 72" long piece, etc. (Please specify at time of order.)

PART NO.	DESCRIPTION	Wgt. (lbs)
WMS1.5	1.5" x 1.5" x 72" wire trough	3
WMS2	2" x 2" x 72" wire trough	4

WIRE MANAGEMENT GROMMET

Mounts into work surface. Location varies between models.

PART NO.	DESCRIPTION	Wgt. (lbs)
WMG	Wire Management Grommet	0.25



SNAP-IN SLOT DESIGN and NON-SLIP COVER TYPE G

Material: PVC (Lead-Free)

- Restricted slot design
- Greater wire capacity
- Push duct and cover mating design
- No-slip cover

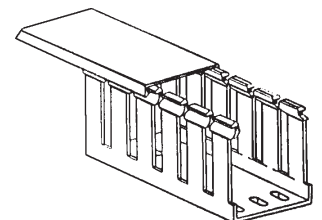

EUROPEAN ELECTRICAL SUPPLIES

(250 VAC from 13 AMP to 16 AMP)

Various sockets and cable plugs to meet different country requirements.

PART NO.	DESCRIPTION	Wgt. (lbs)
EE525016A	5 outlets 250vac 16 amp 566.0cm x 51.6cm cord 2.5m continental Europe	1.18
EE525013D	4 outlets 250vac 13 amp 317.0cm x 68.0cm cord 2.5m United Kingdom/Ireland	0.69
EE525015F	5 outlets 250vac 15 amp 566.0cm x 50.0cm cord 2.5m France/Belgium	1.27

A

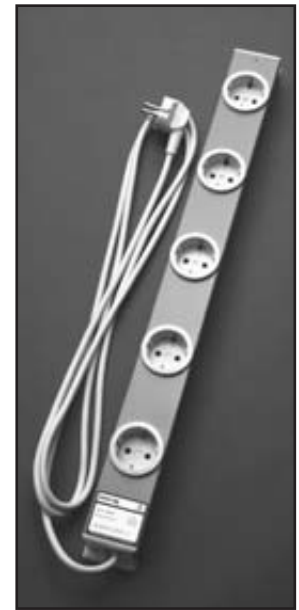

F



D



ACCESSORIES

E.S.D. GROUND KITS

PART NO.	DESCRIPTION	Wgt. (lbs)	Wgt. (kgs)
SGK-1	Standard Ground Kit	¼	.1
SGK-J2	Standard Ground Kit w/Banana Plug Jacks	½	.2
FGK-1	Flush Mount Ground Kit w/Jacks	½	.2
SGS-4	Standard Ground Wrist Strap 6' Cord	¼	.1

RETROFIT KIT

Pro-Line's retrofit kits are designed to turn a non-modular bench into a modular workstation. Simply set your legs to the same centers as Pro-Lines centers and you can mount any of our over worksurface accessories. Following is a guide on the outside dimensions of our accessories.

For a 48"L station 42.5"

For a 60"L station 54.5"

For a 72"L station 66.5"

For a 96"L station 87.5"

PART NO.	DESCRIPTION	Wgt. (lbs)
RK30	Retrofit Kit for a 30" deep worksurface	32
RK36	Retrofit Kit for a 36" deep worksurface	33



WRIST STRAP



CHATTER/PRIVACY SHIELDS

These shields are designed to mount to the back of our Heavy Duty Uprights. Shields are ideal to close off workstations from high traffic areas. Shields are available in both painted steel and plastic laminate. **To mount to our standard uprights drilling is required.**



GUARD RAIL

3" High painted steel guardrails meet in rear corners of work surface. Keeps small items from rolling off surface. Sold in set of one rear guard and two side guards. Mounts to top of work surface.



PART NO.	DESCRIPTION	WGT. (LBS)
CPS48PL	Chatter Shield for 48"L station Plastic Laminate 48" x 36"	35
CPS60PL	Chatter Shield for 60"L station. Plastic Laminate 60" x 36"	44
CPS72PL	Chatter Shield for 72"L station. Plastic Laminate 72" x 36"	53
CPS48ST	Chatter Shield for 48"L station. Painted Steel 48" x 36"	27
CPS60ST	Chatter Shield for 60"L station. Painted Steel 60" x 36"	44
CPS72ST	Chatter Shield for 72"L station. Painted Steel 72" x 36"	53

PART NO.	DESCRIPTION	WGT. (LBS)
GR4830	Guard Rail for 48" x 30" station	6
GR4836	Guard Rail for 48" x 36" station	8
GR6030	Guard Rail for 60" x 30" station	10
GR6036	Guard Rail for 60" x 36" station	12
GR7230	Guard Rail for 72" x 30" station	12
GR7236	Guard Rail for 72" x 36" station	14
GR9630	Guard Rail for 96" x 30" station	18
GR9636	Guard Rail for 96" x 36" station	20



Model S8352

PRO-LINE SEATING

2 to 3 week lead time for shipping

If any component of your Pro-Line seating ever becomes defective, Pro-Line will repair or replace that chair for up to 12 years.

Pro-Line = best price and the best guarantee in seating.

All Pro-Line chairs are manufactured to meet or exceed California flammability code 117, BIFMA F-1-1978 and mvss302 standards

Featuring:

- Pneumatic height adjust - three ranges:
 1. Standard 18" - 24"
 2. Mid 20" - 27.5"
 3. High 24" - 33"
- Waterfall edge (leg comfort).
- 5 Star cast aluminum base.
- Glides come standard with all models.



Model S8351
Shown with optional arms and casters



Model S8350
Shown with optional casters

HOW TO ORDER

SEATING

Description	S Series Low Hgt.	Black Vinyl	Std Arm Rest, Breaking Caster
Example Part #	S8350	9	8255,BC-5
	Model	Upholstery	Optional Accessories

Example S835098255BC-5

FRAMES

All models come standard with Chrome Frame and Polished Aluminum Base.

Colors* See Inside Back Cover Color Chart

UPHOLSTERY FABRIC/VINYL

S Series

Fabrics

1. Burgundy
2. Med Blue
3. Royal Blue
4. Navy Blue
5. Beige
6. Green
7. Gray
8. Black

Vinyl

9. Black
10. Royal blue

E Series

ESD Fabrics

11. Slate Blue
12. Navy Blue
13. Gray
14. Charcoal

CLEAN ROOM

ESD Vinyl

15. Black
16. Royal Blue



Model S8350

Model S8351
With Optional
Arms



Model S8352

WATERFALL EDGE STANDARD TASK SEATING

SERIES	MODEL	HEIGHT RANGE	FOOT RING	Glides Standard	Casters Optional	Wgt. (lbs)
S	S8350	18" - 24"	optional	included	C-8, C7 & BC-5	31
	S8351	20" - 27.5"	included	included	C-8, C7 & BC-6	38
	S8352	24" - 33"	included	included	C-8, C7 & BC-7	38.5

ESD SEATING

	MODEL	HEIGHT RANGE	FOOT RING	ESD Glides Standard	Casters Optional	Wgt. (lbs)
E	E8460	18" - 24"	optional	included	C-8, C7 & BCC	31
	E8461	20" - 27.5"	included	included	C-8, C7 & BCC	38
	E8462	24" - 33"	included	included	C-8, C7 & BCC	38.5

CLASS 100 CLEANROOM SEATING

	MODEL	HEIGHT RANGE	FOOT RING	CR Glides Standard	Casters Optional	Wgt. (lbs)
CR	CR8570	18" - 24"	optional	included	C-8, C7 & BCC	31
	CR8571	20" - 27.5"	included	included	C-8, C7 & BCC	38
	CR8572	24" - 33"	included	included	C-8, C7 & BCC	38.5

OPTIONAL ACCESSORIES

CASTER OPTIONS	Model
Dual Wheel non braking carpet caster	C-8
Dual Wheel non braking hard floor caster	C-7
ESD Dual Wheel non braking carpet caster	CC-8
ESD Dual Wheel non braking hard floor caster	CC-7
Dual Wheel braking caster	BC-5
ESD Dual Wheel braking caster	BCC-6
ARM OPTIONS	
Standard Black	8255
ESD (E Only) Chrome	8256C
Foot Ring	FRACF-20

Glides come standard with ALL chairs

OPTIONAL CASTERS

C-8 Casters – Ideal for carpeted floors.

BC-5 Braking Casters apply “brake” when seat is unoccupied – prevents seating from moving out from under operator during repeated sit/stand applications.

CC8/CC7 Conductive Casters for E and CR mobile ESD applications.

BCC-6 Braking Conductive Casters for E and CR Series. Used for mobile ESD applications on hard floors.

*Caster prices vary when purchased separately

CALL US TOLL FREE IF ADDITIONAL INFORMATION IS REQUIRED 1-800-739-9067

SECTION VI

MATERIAL HANDLING PRODUCTS

PORTABLE HYDRAULIC SCISSOR LIFTS

Six fully hydraulic models load rated from 300 lbs to 1500 lbs. Three height ranges to choose from. Foot pump or battery operation. Provide quick and effortless lifting and lowering. Use with our Mobile Retractable Ball Transfers. **Note:** Shown with optional MRBT. Pricing excludes retractable ball transfer platform.



Shown with hydraulic lift. Sold separately. Height is 7³/₈". Pricing excludes mobile scissor lift.

PART NO.	CAPACITY	MAX. HEIGHT	PLATFORM SIZE	LOW HEIGHT	STROKES	Wgt. lbs
PSL-1	300	33"	20"W x 32"L	10"	12	150
PSL-2	600	33"	20"W x 32"L	10"	25	160
PSL-3	1000	33"	24"W x 36"L	9.25"	35	335
PSL-4	1500	33"	24"W x 36"L	9.25"	55	340
PSL-5	1000	45"	24"W x 48"L	9.25"	46	390
PSL-6	1500	45"	24"W x 48"L	9.25"	69	395
Battery Operated Lifts						
BPL-1	1000	33"	24"W x 36"L	9.25"	8 sec	420
BPL-2	1000	45"	24"W x 48"L	9.25"	14 sec	425

MOBILE RETRACTABLE BALL TRANSFERS

These Retractable Ball Transfers are available with both lever and air operation. Our SD model has a 200 lb capacity with the transfers on a 6" x 6" pattern. Our HD model has a 500 lb capacity with the transfers on a 3" x 6" pattern.

MOBILE RETRACTABLE BALL TRANSFER AIR OPERATED

PART NO.	DESCRIPTION	Wgt. (lbs)	Wgt. (kgs)
MRBT1824-ASD	18"W x 24"L 6x6 45.72cm x 60.96cm	56	25.4
MRBT2424-ASD	24"W x 24"L 6x6 60.96cm x 60.96cm	66	30
MRBT2430-ASD	24"W x 30"L 6x6 60.96cm x 76.20cm	78	35.4
MRBT2436-ASD	24"W x 36"L 6x6 60.96cm x 91.44cm	89	40.4
MRBT3030-ASD	30"W x 30"L 6x6 76.20cm x 76.20cm	88	40
MRBT3036-ASD	30"W x 36"L 6x6 76.20cm x 91.44cm	98	44.5
MRBT3636-ASD	36"W x 36"L 6x6 91.44cm x 91.44cm	106	48.1

MOBILE RETRACTABLE BALL TRANSFER LEVER OPERATED

PART NO.	DESCRIPTION	Wgt. (lbs)	Wgt. (kgs)
MRBT1824-LSD	18"W x 24"L 6x6 45.72cm x 60.96cm	56	25.4
MRBT2424-LSD	24"W x 24"L 6x6 60.96cm x 60.96cm	66	30
MRBT2430-LSD	24"W x 30"L 6x6 60.96cm x 76.20cm	78	35.4
MRBT2436-LSD	24"W x 36"L 6x6 60.96cm x 91.44cm	89	40.4
MRBT3030-LSD	30"W x 30"L 6x6 76.20cm x 76.20cm	88	40
MRBT3036-LSD	30"W x 36"L 6x6 76.20cm x 91.44cm	98	44.5
MRBT3636-LSD	36"W x 36"L 6x6 91.44cm x 91.44cm	106	48.1

HIGH DENSITY

PART NO.	DESCRIPTION	Wgt. (lbs)
MRBT1824-LHD	18"W x 24"L 3" x 6" pattern	65
MRBT2424-LHD	24"W x 24"L 3" x 6" pattern	76
MRBT2430-LHD	24"W x 30"L 3" x 6" pattern	88
MRBT2436-LHD	24"W x 36"L 3" x 6" pattern	99
MRBT3030-LHD	30"W x 30"L 3" x 6" pattern	98
MRBT3036-LHD	30"W x 36"L 3" x 6" pattern	108
MRBT3636-LHD	36"W x 36"L 3" x 6" pattern	116

HIGH DENSITY

PART NO.	DESCRIPTION	Wgt. (lbs)
MRBT1824-AHD	18"W x 24"L 3" x 6" pattern	65
MRBT2424-AHD	24"W x 24"L 3" x 6" pattern	76
MRBT2430-AHD	24"W x 30"L 3" x 6" pattern	88
MRBT2436-AHD	24"W x 36"L 3" x 6" pattern	99
MRBT3030-AHD	30"W x 30"L 3" x 6" pattern	98
MRBT3036-AHD	30"W x 36"L 3" x 6" pattern	108
MRBT3636-AHD	36"W x 36"L 3" x 6" pattern	116

- (L) Lever Operated
- (A) Air Operated
- (SD) 6"x6" Standard Density
- (HD) 3"x6" High Density

Shown with hydraulic lift. Sold separately. Height is 7³/₈". Pricing excludes mobile scissor lift.



MODEL DIRBT (THE INLINE WORKSTATION)

Drop in RBT unit is the same construction as the work surface and ball grid of the RBT – with mounting rails matched to the inside frame dimension of your conveyor – when assembled, balls in up position match height of rollers. **Conveyor not included.** Shop air required.

PART NO.	DESCRIPTION	Wgt. (lbs)	Wgt. (kgs)
DIRBT2424SD	24"L x 24"W 6x6 BP 60.96cm x 60.96cm	58	26.3
DIRBT2430SD	24"L x 30"W 6x6 BP 60.96cm x 76.20cm	64	29
DIRBT2436SD	24"L x 36"W 6x6 BP 60.96cm x 91.44cm	88	40
DIRBT2448SD	24"L x 48"W 6x6 BP 60.96cm x 121.92cm	110	50
DIRBT2424HD	24"L x 24"W 3x6 BP 60.96cm x 60.96cm	69	31.3
DIRBT2430HD	24"L x 30"W 3x6 BP 60.96cm x 76.20cm	81	36.8
DIRBT2436HD	24"L x 36"W 3x6 BP 60.96cm x 91.44cm	109	49.5
DIRBT2448HD	24"L x 48"W 3x6 BP 60.96cm x 121.92cm	138	62.7



LEAN MANUFACTURING (Point of use storage) Flow Racking

Store components at the point of use and eliminate materials handling. Includes two adjustable tiers of 48" long rollers. Each tier includes (3)- 9" wide rollers with front lip, additional tiers are available.

Show with optional light and power supply, see page 17 for more optional accessories



Please consult the factory for additional roller racks and other available sizes

Point of use storage flow racking with 60" x 30" surface that adjusts from 30" to 36" high. 65"H to 96.250 with adjustable cross members set all the way in.

Part Number	Plastic Laminate	ESD Laminate
POS6030	POS6030PL	POS6030ESD

Additional shelves for point of use storage flow racking include: Two lateral braces and three 9" wide rollers with front lip.

Part Number	Plastic Laminate	ESD Laminate
POSAS	NA	NA

FLOW RACKING

Need to neatly organize and queue components?

Pull kits from your stock room and load the flow rack. Gravity flow will then feed your tote to station. Pro-Line's structural steel "U" channel frame allows you to set shelf at your required height. Use with a workstation or order optional laminate shelf and work off rack. 48"W x 36"D x 80"H.

Unit comes with two shelves, for additional shelves see chart below.



PART NO.	DESCRIPTION	WGT. (LBS)
FOR4836	Flow rack with two shelves 48"Wx36"Dx80"H	290
FORAS	Additional Shelf for rack 48"Wx36"D	105
FORCS1248	Cantilever Laminate Shelf For Flow Rack. 12"D x 48"W	25

MATERIALS HANDLING



THREE SHELF SERVICE TRUCK

48" High. Four swivel casters plus handle. Steel construction. Fixed height shelves.

PART NO.	DESCRIPTION	Wgt. (lbs)
ST1836	3 Shelf Truck 18" x 36"	84
ST1848	3 Shelf Truck 18" x 48"	100
ST2436	3 Shelf Truck 24" x 36"	100
ST2448	3 Shelf Truck 24" x 48"	133



KITTING CART

Attractive, professional cart brings kits from stockroom to assembly. Totes included.

Tote size 16½"L x 11"W x 3½"H.
Worksurface 24"W x 36"L x 38"H.
Shelf size 9"W x 36"L.

PART NO.	DESCRIPTION	Wgt. (lbs)
KC-1	Kitting Cart	135

TURN TABLES

Why run around your sub-assemblies? These turn tables allow you to stay seated while your product can be rotated 360° and lock into position at various intervals. 30" or 36" high. Please specify. Call for low profile models.

PART NO.	DESCRIPTION	Wgt. (lbs)
TT36	36" Dia. Table	110
TT48	48" Dia. Table	135



UTILITY CART

Utility Cart comes complete with two shelves and four casters two rigid and two swivel with brake. Painted steel construction. Height 30"

PART NO.	DESCRIPTION	Wgt. (lbs)
UT1824	Cart 18"W x 24"L	40
UT1836	Cart 18"W x 36"L	45
UT2424	Cart 24"W x 24"L	50
UT2436	Cart 24"W x 36"L	60

BIN HOLDER CART

The Bin Holder Cart is an easy way to transport small parts. Comes complete as shown with 12 bin holders. Bin holders are adjustable on the open frame so you can configure cart as you need it.

PART NO.	DESCRIPTION	Wgt. (lbs)
BHC3648	Bin Holder Cart 36"W x 48"H	85
BHC4848	Bin Holder Cart 48"W x 48"H	98
BHC3666	Bin Holder Cart 36"W x 66"H	108
BHC4866	Bin Holder Cart 48"W x 66"H	115

O.A.H.
85.25"



WORKSTATION FEED CART

Allows kits to be loaded at the stock room and wheeled into assembly. Gravity flow then feeds workstation. Call for custom sizes. Standard unit comes with two (2) 48" x 36" adjustable steel shelves at a 25° angle. Ball transfer shelves available upon request.

PART NO.	DESCRIPTION	Wgt. (lbs)
FC-1	Feed Cart	92
S4836	Additional Shelf	35





CANTILEVER SHELF CART

The Pro-Line Cantilever Shelf Cart comes complete with three shelves that are easily adjusted. The shelves are available in both standard laminate and ESD laminate. Price includes one set of casters with two swivel casters with brakes and two rigid casters. Shelves are 12" deep. Price also includes one fixed bottom shelf 18" deep.

PART NO.	DESCRIPTION	Wgt. (lbs)
CSC3648	Shelf Cart 36" L x 48" H	99
CSC4848	Shelf Cart 48" L x 48" H	123
CSC3660	Shelf Cart 36" L x 60" H	109
CSC4860	Shelf Cart 48" L x 60" H	133

ADJUSTABLE TRAY / PCB CART



ATPBC7060

Adjustable Tray / PCB cart. Quickly reconfigure rack to transport different size trays or boards. Center uprights adjust left or right on .5" centers and lock with spring loaded pin. Horizontal rails adjust on 1.75" centers. Offset cam locks load into place for transport.

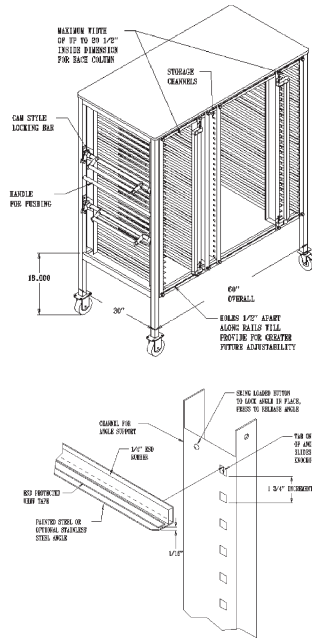

PART NO.	DESCRIPTION	Wgt. lbs.	Wgt. Cap.
ATPBC7060	60" L x 30" W x 72" H Adjustable Cart	345	800

LAMINATE SHELF CARTS

Regular laminate or E.S.D. These attractive yet sturdy mobile 4 shelf units give your assembly areas a professional, clean appearance. Three (3) adjustable height shelves per unit. Two swivel/Two brake casters. 60" overall height. Top shelf is fixed.



"When you want your mobile shelving to coordinate with your workstations for a uniform systems look."

BOOK CART / TRANSPORT CART



Four tier durable powder coat painted steel transport cart. Swivel casters for ease of use in tight spaces. Fork pockets included to load with a fork truck. 60" high x 24" wide x 42" long.

PART NO.	DESCRIPTION	Wgt. lb	Wgt. Cap.
TCBC6024	42" L x 24" W x 60" H Book Cart	259	600

BASE PART NO./SIZE	PLASTIC LAMINATE		E.S.D. LAMINATE	
	Wgt. (lbs)	Wgt. (cap)	Wgt. (lbs)	Wgt. (cap)
PS1848	PS1848PL	PS1848ESD		
18" x 48"	150 200	150 200	150 200	150 200
PS1860	PS1860PL	PS1860ESD		
18" x 60"	170 250	170 250	170 250	170 250
PS1872	PS1872PL	PS1872ESD		
18" x 72"	195 300	195 300	195 300	195 300
PS2448	PS2448PL	PS2448ESD		
24" x 48"	175 225	175 225	175 225	175 225
PS2460	PS2460PL	PS2460ESD		
24" x 60"	200 275	200 275	200 275	200 275
PS2472	PS2472PL	PS2472ESD		
24" x 72"	235 325	235 325	235 325	235 325

MOBILE STORAGE CARTS

Configure the cart to meet your requirement, with Pro-Line's modular design it's easy. Start with our base cart and add the options you need. Carts are 24" wide and either 48" or 66" high. O.A.H. 55.250" or 73.250". fully welded steel frames allow for infinite adjustability. Unit supplied with a set of casters, 2 rigid and 2 total lock.

PART NO.	DESCRIPTION	WGT. (LBS)
MC2448	Mobile Storage Cart 24"Wx48"H	82
MC2466	Mobile Storage Cart 24"Wx66"H	94



Note: Carts roll left to right.

OPTIONAL ACCESSORIES

PART NO.	DESCRIPTION	WGT. (LBS)
CSPL1224FL	Plastic Laminate Shelf 12"Wx24"L	12
BH24FL	Bin Holder 24"L	0.8
LBP24FL	Louvered Bin Panel	14
SPB24FL	Steel Pegboard 24"x24"	6
ESMR24FL	Electrical Supply Mounting Rail for 24"W Flexline	0.8
ES12	12" Power Supply	0.8

REEL TRANSPORT CART

Transport and store reels of wire. Includes collars to captivate reels

PART NO.	DESCRIPTION	WGT. (LBS)
RTC	Reel Transport Cart	38

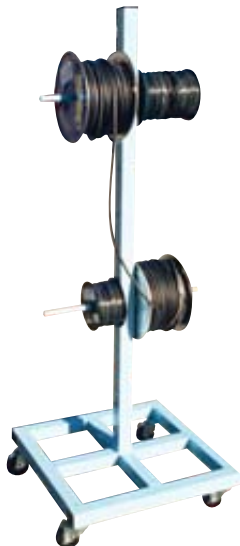

REEL FEED CART

Wire spool holders mounted onto our mobile storage carts. Unit easily rolls behind a work station.

PART NO.	DESCRIPTION	WGT. (LBS)
RFC	Reel Feed Cart 24"W x 48"H	80



PRO-LINE WORKSURFACES

Pro-Line has a variety of work surfaces to choose from. Pro-Line's standard work surface, and our most popular, is a plastic laminate surface with "T" mold edges. These surfaces are available in both standard and ESD laminate. With radius corners and "T" mold edges, it is durable, economical and worker friendly. For class 100 clean room and below we offer a self edge work surface. These surfaces are finished on all four sides with square edges that match the work surface. For added clean room protection we can laminate the bottom of our self edge work surfaces and our rolled front edge surfaces. Pro-Line also offers solid maple work surfaces. These work surfaces are 1.750" thick and both front and rear edges of the surface are eased for worker comfort. Our last standard work surface is a stainless steel 16 ga. 304 2B finish surface. They are 1.5" thick and both front and rear have an eased edge. Side edges are square. Should you need a work surface not listed here, feel free to give us a call. We also offer galvanized steel surfaces

Base Part No./ Size	Plastic Laminate .125	ESD Laminate .125	Solid Maple 1.75"	Chem Guard® 1.25"	HDPE 1"	Black Epoxy Resin 1"	Stainless Steel 1.25"
WS4830 48"x30"	WS4830PL Wgt. Lbs 45	WS4830ESD Wgt. Lbs 45	WS4830SM Wgt. Lbs 70	WS4830CG Wgt. Lbs 45	WS4830HDPE Wgt. Lbs 46	WS4830ER Wgt. Lbs 110	WS4830SS Wgt. Lbs 70
WS4836 48"x36"	WS4836PL Wgt. Lbs 54	WS4836ESD Wgt. Lbs 54	WS4836SM Wgt. Lbs 84	WS4836CG Wgt. Lbs 54	WS4836HDPE Wgt. Lbs 55	WS4836ER Wgt. Lbs 132	WS4836SS Wgt. Lbs 84
WS6030 60"x30"	WS6030PL Wgt. Lbs 56	WS6030ESD Wgt. Lbs 56	WS6030SM Wgt. Lbs 87	WS6030CG Wgt. Lbs 56	WS6030HDPE Wgt. Lbs 58	WS6030ER Wgt. Lbs 138	WS6030SS Wgt. Lbs 87
WS6036 60"x36"	WS6036PL Wgt. Lbs 68	WS6036ESD Wgt. Lbs 68	WS6036SM Wgt. Lbs 105	WS6036CG Wgt. Lbs 68	WS6036HDPE Wgt. Lbs 69	WS6036ER Wgt. Lbs 165	WS6036SS Wgt. Lbs 106
WS7230 72"x30"	WS7230PL Wgt. Lbs 68	WS7230ESD Wgt. Lbs 68	WS7230SM Wgt. Lbs 105	WS7230CG Wgt. Lbs 68	WS7230HDPE Wgt. Lbs 69	WS7230ER Wgt. Lbs 165	WS7230SS Wgt. Lbs 106
WS7236 72"x36"	WS7236PL Wgt. Lbs 81	WS7236ESD Wgt. Lbs 81	WS7236SM Wgt. Lbs 126	WS7236CG Wgt. Lbs 81	WS7236HDPE Wgt. Lbs 83	WS7236ER Wgt. Lbs 198	WS7236SS Wgt. Lbs 119
WS9630 96"x30"	WS9630PL Wgt. Lbs 90	WS9630ESD Wgt. Lbs 90	WS9630SM Wgt. Lbs 140	WS9630CG Wgt. Lbs 90	WS9630HDPE Wgt. Lbs 92	WS9630ER Wgt. Lbs 220	Special Order Call for Pricing
WS9636 96"x36"	WS9636PL Wgt. Lbs 108	WS9636ESD Wgt. Lbs 108	WS9636SM Wgt. Lbs 168	WS9636CG Wgt. Lbs 108	WS9636HDPE Wgt. Lbs 110	WS9636ER Wgt. Lbs 264	
Edges	"T" Mold	"T" Mold	Eased	Square Edge	Eased Edge	Square Edge	Square Edge

Light Shaded area "In Stock" 

Note: ESD Surfaces require a grounding kit. See page 42

ROLLED EDGE FOR STANDARD LAMINATE AND ESD LAMINATE SURFACES

Part No.	
PF180	180° Rolled Front Edge
PF90	90° Rolled Front Edge

PF90 "In Stock"

60"x 30" and 72"x 30"
60"x 36" and 72"x 36"

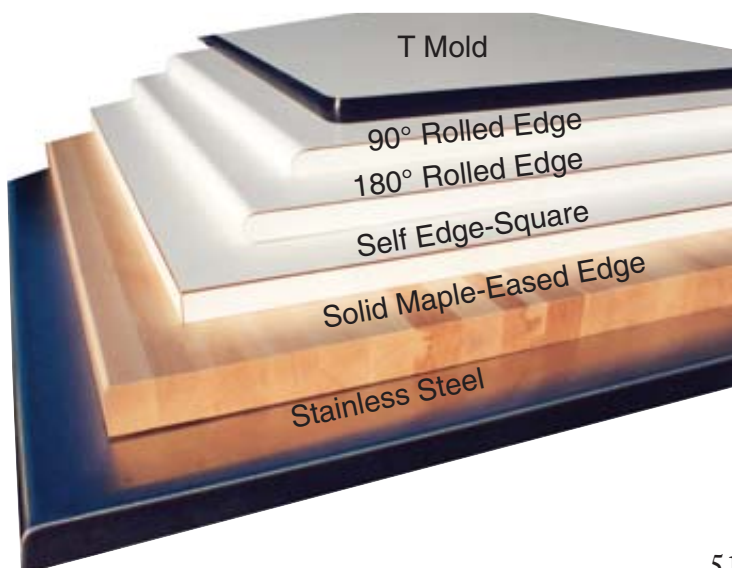

GALVANIZED STEEL WORK SURFACE UPCHARGE

Add the letters GS to the end of our part number for the model you have chosen. **Note:** This Upcharge does not include RT or MRBT products. This applies to both, galvanized and stainless steel.

PART NO.	DESCRIPTION	Wgt. (lbs)
4830GS	48" x 30" Work Surface Up.	70
4836GS	48" x 36" Work Surface Up.	84
6030GS	60" x 30" Work Surface Up.	87
6036GS	60" x 36" Work Surface Up.	106
7230GS	72" x 30" Work Surface Up.	106
7236GS	72" x 36" Work Surface Up.	119

Pro-Lab Series

Modular Laboratory Furniture

Available in Powder Coat Textured Finish Only



- Heavy Duty Modular Cabinets. 16 gauge steel
- 95% extension slides with 100 pounds capacity
- Recessed handles & Polished aluminum (recessed handle shown)

• Available in Powder Coat Textured Finish Only

Shown Two Tone Textured Blue & Textured Beige

- Pedestal drawers available with optional gang lock

Standard Textured Colors



Standard cabinets are 18"W x 27.5"H x 26" or 30"D Cabinet bases are available in three standard heights 3", 6", and 9". 1" adjustment with glide. Work surfaces vary from 1" to 1.75" thick.



Easily Configure your lab to meet your needs.



Mobile Cabinet bases are also available







Inside of drawers are designed to accept dividers every 1"















- Various Surfaces available
- Epoxy Resin
- Chem-Guard® "chemical resistant laminate"
- Colored laminates
 - ESD laminate
 - HDPE
 - Stainless steel
- Multi-tiered adjustable shelving
- Double or Single Swing Door Sink Base Stainless Steel sinks
- Modular Cabinets easily reconfigure drawer combinations
- All housings accept both drawers and swing doors
- Swing door cabinets include one adjustable shelf
- Adjustable glides for level installation



Heavy Duty Modular Cabinets **18" wide x (26" and 30" deep) x 27.5" high** (without optional base)
 Drawers feature 95% extension slides with 100 pounds capacity per drawer. Inside of drawers are slotted to accept optional dividers every 1" for optimal organization. Cabinet bases include leveling feet.

	Swing Door Right	Swing Door Left		Swing Door Right	Swing Door Left	
26"D	C4-626	C1-6-SDR26	C1-6-SDL26	C2-61-1226	CSDR26	CSDL26
30"D	C4-630	C1-6-SDR30	C1-6-SDL30	C2-61-1230	CSDR30	CSDL30
						
	6" Drawer (4x)	6" Drawer (1x) 18" Locker w/shelf (1x)	6" Drawer (1x) 18" Locker w/shelf (1x)	6" Drawer (2x) 12" Drawer (1X)	24" Locker w/shelf (1x)	24" Locker w/shelf (1x)
Wgt 26"	(118 lbs)	(87 lbs)	(87 lbs)	(111 lbs)	(76 lbs)	(76 lbs)
Wgt 30"	(132 lbs)	(99 lbs)	(99 lbs)	(125 lbs)	(87 lbs)	(87 lbs)

			Swing Door Right	Swing Door Left	Swing Door Right	Swing Door Left
26"D	C4-3-2-626	C2-1226	C8-326	C2-6-SDR26	C2-6-SDL26	C2-3-SDR26
30"D	C4-3-2-630	C2-1230	C8-330	C2-6-SDR30	C2-6-SDL30	C2-3-SDR30
						
	3" Drawer (4x) 6" Drawer (2x)	12" Drawer (2x)	3" Drawer (8x)	6" Drawer (2x) 12" Locker (1X)	6" Drawer (2x) 12" Locker (1X)	3" Drawer (2x) 18" Locker w/shelf (1x)
Wgt 26"	(127 lbs)	(104 lbs)	(136 lbs)	(95.5 lbs)	(95.5 lbs)	(91.5 lbs)
Wgt 30"	(141 lbs)	(118 lbs)	(152 lbs)	(107 lbs)	(107 lbs)	(102 lbs)

	Swing Door Right	Swing Door Left		Swing Door Right	Swing Door Left	CSB2SDRL Sink Base 36" wide double swing door (110lbs)	
26"D	C4-3-SDR26	C4-3-SDL26	C4-3-1-1226	C2-SDR26	C2-SDL26		
30"D	C4-3-SDR30	C4-3-SDL30	C4-3-1-1230	C2-SDR30	C2-SDL30		
							
	3" Drawer (4x) 12" Locker (1X)	3" Drawer (4x) 12" Locker (1X)	3" Drawer (4x) 12" Drawer (1X)	12" Locker (2X)	12" Locker (2X)		
Wgt 26"	(104.5 lbs)	(104.5 lbs)	(120 lbs)	(73 lbs)	(73 lbs)	CSB2SDRL26	26" Deep
Wgt 30"	(116 lbs)	(116 lbs)	(134 lbs)	(84 lbs)	(84 lbs)	CSB2SDRL30	30" Deep



Gang Locks Sold Separately for drawers
 Part No. CGL
 Swing door pricing includes lock.

Drawer Dividers	
Part No.	Wgt
3' DD3	(1.5) lbs
6' DD6	(2.5) lbs
12' DD12	(4.5) lbs

Galvanized Steel, see page 57 for other options

Need A Mobile Unit*?
 Add "M" to the end of the part#
 Ex. CB3-26M
 *See page 40 for Casters
 See page 57 for example

Cabinet Bases	
Part No. wgt	Description
CB3-26 (6 lbs)	3"H x 24"L O.A.H 30.5"
CB3-30 (7 lbs)	3"H x 28"L O.A.H 30.5"
CB6-26 (13 lbs)	6"H x 24"L O.A.H 33.5"
CB6-30 (15 lbs)	6"H x 28"L O.A.H 33.5"
CB9-26 (18 lbs)	9"H x 24"L O.A.H 36.5"
CB9-30 (21 lbs)	9"H x 28"L O.A.H 36.5"

LAMINAR FLOW STATION “CLASS 100”



Modular free-standing unit. Operates on 120V 15 AMP electric. Other sizes and work surfaces available. Please consult factory.

- 99.99% efficient HEPA filter at .3 microns or larger.
- 1" disposable fiberglass prefilter.
- Variable speed control. Air velocity from 50-120 FPM.
- UL Approved.
- O.A.H. 80"
- Standard height of surface 30" H
- Surface enclosed on three sides.
- Quiet <65 db. motor

Base Part No./Size	PLASTIC LAMINATE		E.S.D. LAMINATE	
CR483030	CR483030PL		CR483030ESD	
48"L x 30"W x30"H	Wgt. (lbs) 225	Wgt. (cap) 400	Wgt. (lbs) 225	Wgt. (cap) 400
CR603030	CR603030PL		CR603030ESD	
60"L x 30"W x30"H	Wgt. (lbs) 281	Wgt. (cap) 400	Wgt. (lbs) 281	Wgt. (cap) 400
CR723030	CR723030PL		CR723030ESD	
72"L x 30"W x30"H	Wgt. (lbs) 330	Wgt. (cap) 400	Wgt. (lbs) 330	Wgt. (cap) 400

Work Surface is set at 30" High

Part# CRRF Replacement Prefilters 12/case

Part# CRHF Replacement HEPA filter

Part# CROL Optional Clean Room light *

*Must be ordered with station

THE CR-MVSII HEIGHT ADJUSTABLE LAMINAR FLOW STATION “CLASS 100”

The CR-MVSII Height Adjustable Cleanroom Station combines two great Pro-line products:

Our electric programmable height adjustable MVS and our CR class 100 clean room station.

Unit adjusts from 30.5" to 46.5" via linear actuator with 100 pound capacity.

HEPA filter specs are the same as Model CR above.

BASE PART NO. / SIZE	PLASTIC LAMINATE		E.S.D.		HDPE	
CRMVSI4830	CRMVSI4830PL		CRMVSI4830ESD		CRMVSI4830HDPE	
48"Lx30"W	Wgt. lbs 190	Wgt. Cap 1000	Wgt. lbs 190	Wgt. Cap 1000	Wgt. lbs 214	Wgt. Cap 1000
CRMVSI4836	CRMVSI4836PL		CRMVSI4836ESD		CRMVSI4836HDPE	
48"Lx36"W	Wgt. lbs 214	Wgt. Cap 1000	Wgt. lbs 214	Wgt. Cap 1000	Wgt. lbs 238	Wgt. Cap 1000
CRMVSI6030	CRMVSI6030PL		CRMVSI6030ESD		CRMVSI6030HDPE	
60"Lx30"W	Wgt. lbs 210	Wgt. Cap 1000	Wgt. lbs 210	Wgt. Cap 1000	Wgt. lbs 240	Wgt. Cap 1000
CRMVSI6036	CRMVSI6036PL		CRMVSI6036ESD		CRMVSI6036HDPE	
60"Lx36"W	Wgt. lbs 230	Wgt. Cap 1000	Wgt. lbs 230	Wgt. Cap 1000	Wgt. lbs 272	Wgt. Cap 1000
CRMVSI7230	CRMVSI7230PL		CRMVSI7230ESD		CRMVSI7230HDPE	
72"Lx30"W	Wgt. lbs 230	Wgt. Cap 1000	Wgt. lbs 230	Wgt. Cap 1000	Wgt. lbs 272	Wgt. Cap 1000
CRMVSI7236	CRMVSI7236PL		CRMVSI7236ESD		CRMVSI7236HDPE	
72"Lx36"W	Wgt. lbs 250	Wgt. Cap 1000	Wgt. lbs 250	Wgt. Cap 1000	Wgt. lbs 292	Wgt. Cap 1000



Shown with optional CROL Clean Room light.

DIMENSION NEXT

LABORATORY MODULAR TECHNICAL SYSTEMS



The Model DNL offers esthetics, flexible modularity and ergonomics. Designed with work surfaces and frames that give you the ultimate laboratory work station. Easily add and adjust optional accessories to meet your needs.

Work surfaces adjust vertically anywhere on the aluminum upright allowing increased operator comfort and production.

Pro-line's overhead cabinets and under-surface modular cabinets allow you to neatly organize and utilize work space.

Optional task lighting, shown mounted under sliding door cabinet, reduces worker fatigue yet takes up very little space

The DNL uses the same frame design as the standard Dimension Next allowing you to save money and space with double-sided units and add-on units.

- Single-sided starter station includes two uprights, two horizontal leg supports, one top frame assembly and one work surface.
- Single-sided add-on station includes one upright, one horizontal leg support, one top frame assembly and one surface.
- Double-sided starter station includes two uprights, two back-to-back horizontal leg supports, two top frame assemblies and two work surfaces.
- Double-sided add-on station includes one upright, one back-to-back horizontal leg support, two top frame assemblies and two work surfaces.

Shown with optional accessories

Single Sided Starter

Base Part No./Size	Epoxy Resin	H.D.P.E.
DNL4830SS 48"L x 30"W Single Starter	DNL4830SSER 48"L x 30"W Wgt. (lbs) 177	DNL4830SSHDPE 48"L x 30"W Wgt. (lbs) 177
DNL6030SS 60"L x 30"W Single Starter	DNL6030SSER 60"L x 30"W Wgt. (lbs) 198	DNL6030SSHDPE 60"L x 30"W Wgt. (lbs) 198
DNL7230SS 72"L x 30"W Single Starter	DNL7230ER 72"L x 30"W Wgt. (lbs) 217	DNL7230SSHDPE 72"L x 30"W Wgt. (lbs) 217

Double Sided Starter

Base Part No./Size	Epoxy Resin	H.D.P.E.
DNL4830DS 48"L x 30"W Double Starter	DNL4830DSER 48"L x 30"W Wgt. (lbs) 280	DNL4830DSHDPE 48"L x 30"W Wgt. (lbs) 280
DNL6030DS 60"L x 30"W Double Starter	DNL6030DSER 60"L x 30"W Wgt. (lbs) 307	DNL6030DSHDPE 60"L x 30"W Wgt. (lbs) 307
DNL7230DS 72"L x 30"W Double Starter	DNL7230DSER 72"L x 30"W Wgt. (lbs) 317	DNL7230DSHDPE 72"L x 30"W Wgt. (lbs) 317

Single Sided Add-on

Base Part No./Size	Epoxy Resin	H.D.P.E.
DNL4830SA 48"L x 30"W Single Add-on	DNL4830SAER 48"L x 30"W Wgt. (lbs) 130	DNL4830SAHDPE 48"L x 30"W Wgt. (lbs) 130
DNL6030SA 60"L x 30"W Single Add-on	DNL6030SAER 60"L x 30"W Wgt. (lbs) 148	DNL6030SAHDPE 60"L x 30"W Wgt. (lbs) 148
DNL7230SA 72"L x 30"W Single Add-on	DNL7230SAER 72"L x 30"W Wgt. (lbs) 168	DNL7230SAHDPE 72"L x 30"W Wgt. (lbs) 168

Double Sided Add-on

Base Part No./Size	Epoxy Resin	H.D.P.E.
DNL4830DA 48"L x 30"W Double Add On	DNL4830DAER 48"L x 30"W Wgt. (lbs) 220	DNL4830DAHDPE 48"L x 30"W Wgt. (lbs) 220
DNL6030DA 60"L x 30"W Double Add On	DNL6030DAER 60"L x 30"W Wgt. (lbs) 260	DNL6030DAHDPE 60"L x 30"W Wgt. (lbs) 260
DNL7230DA 72"L x 30"W Double Add On	DNL7230DAER 72"L x 30"W Wgt. (lbs) 300	DNL7230DAHDPE 72"L x 30"W Wgt. (lbs) 300

For Additional information on this system
See pages 14 and 15

Free standing Cleanroom Hard and soft side

Free standing Cleanroom hard and soft side shown with two class 100 HEPA filters.
Shown 63" wide x 100" long x 80" high. (Call with your requirements for pricing)

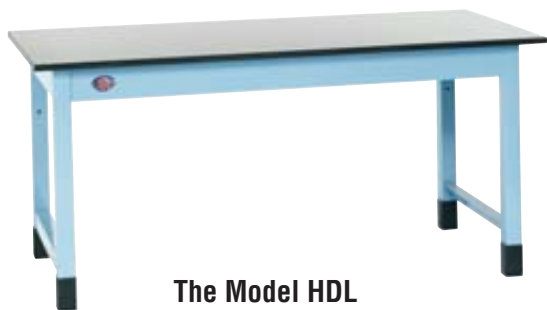

The Model HDL

The Model HDL is a sturdy four leg design station. Features include 4" front, back and side rails to support the work surface. 4" high rail allows operator to sit at both sides. Price also includes PVC boot for each leg to protect station during clean ups. Standard height 30" high. Additional charge for other heights

BASE PART NO./SIZE	STAINLESS STEEL	EPOXY RESIN	CHEM-GUARD®
HDL4830 48"L x 30"W	HDL483030SS Wgt. (lbs) 130	HDL483030ER Wgt. (lbs) 187	HDL483030CG Wgt. (lbs) 100
HDL4836 48"L x 36"W	HDL483630SS Wgt. (lbs) 138	HDL483630ER Wgt. (lbs) 212	HDL483630CG Wgt. (lbs) 108
HDL6030 60"L x 30"W	HDL603030SS Wgt. (lbs) 146	HDL603030ER Wgt. (lbs) 224	HDL603030CG Wgt. (lbs) 115
HDL6036 60"L x 36"W	HDL603630SS Wgt. (lbs) 163	HDL603630ER Wgt. (lbs) 255	HDL603630CG Wgt. (lbs) 125
HDL7230 72"L x 30"W	HDL723030SS Wgt. (lbs) 168	HDL723030ER Wgt. (lbs) 263	HDL723030CG Wgt. (lbs) 130
HDL7236 72"L x 36"W	HDL723630SS Wgt. (lbs) 530	HDL723630ER Wgt. (lbs) 530	HDL723630CG Wgt. (lbs) 530

The Model HDSS incorporates the design of the model HD four-leg station in use since 1978. However, it features a stainless steel frame. Able to ship knocked down or fully assembled with three standard work surfaces offered: Stainless Steel, Epoxy Resin or Chem-Guard® chemical resistant laminate. With an 8" backrail and 2" front rail, this station is built to last. Standard height 30"

BASE PART NO./SIZE	STAINLESS STEEL	EPOXY RESIN	CHEM-GUARD®
HDSS4830 48"L x 30"W	HDSS483030SS Wgt. (lbs) 140	HDSS483030ER Wgt. (lbs) 191	HDSS483030CG Wgt. (lbs) 110
HDSS4836 48"L x 36"W	HDSS483630SS Wgt. (lbs) 148	HDSS483630ER Wgt. (lbs) 222	HDSS483630CG Wgt. (lbs) 118
HDSS6030 60"L x 30"W	HDSS603030SS Wgt. (lbs) 156	HDSS603030ER Wgt. (lbs) 234	HDSS603030CG Wgt. (lbs) 125
HDSS6036 60"L x 36"W	HDSS603630SS Wgt. (lbs) 173	HDSS603630ER Wgt. (lbs) 265	HDSS603630CG Wgt. (lbs) 135
HDSS7230 72"L x 30"W	HDSS723030SS Wgt. (lbs) 178	HDSS723030ER Wgt. (lbs) 273	HDSS723030CG Wgt. (lbs) 140
HDSS7236 72"L x 36"W	HDSS723630SS Wgt. (lbs) 195	HDSS723630ER Wgt. (lbs) 307	HDSS723630CG Wgt. (lbs) 150



Architects and Facility Engineers

Send us a copy of your layout for details and pricing...

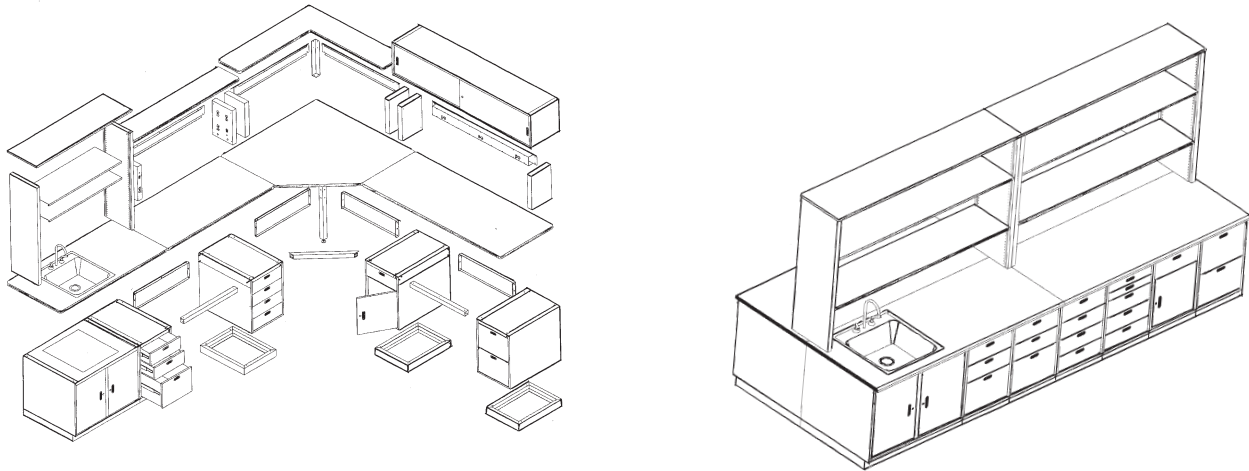

Sample Configurations



Mobile cabinet base

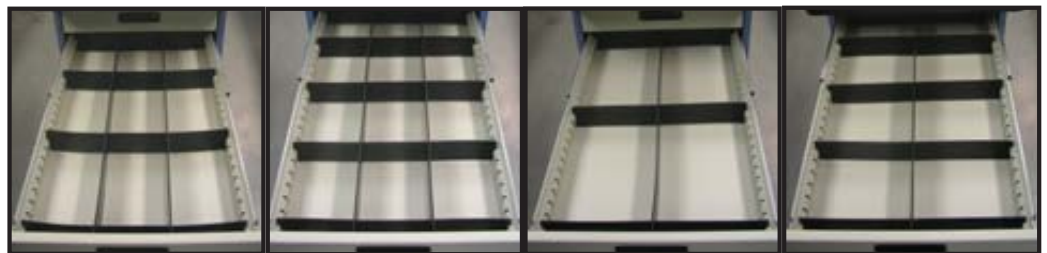

**Optional ESD/UHMW Drawer dividers available in a variety of configurations
Please call for details and reference part no.**

How to design your own modular lab bench

- A...Choose a base**
Need options above the surface?
- B...Select uprights**
Going mobile?
- C...Select casters**
Need a footrest?
- D...Select footrest**
Require under surface storage?
- E/F...Select drawers or cabinets**
Need power?
- G/H...Choose power supply**
Need under shelf lighting?
- I...Select a light**
Need overhead storage?
- J...Select a cabinet or shelving**
Need wire management?
- K...Select a wire trough**



Model #	Page#
HDL603034CG.....	56 A
UR60.....	27 B
TLC-4.....	40 C
FR60.....	29 D
C1-6-SDL26.....	53 E
C1-6-SDR26.....	53 F
ESMR60.....	29 G
ES48.....	29 H
LT48.....	28 I
SDC60/SGLD.....	31 J
WMS1.5.....	41 K

PAINTED STEEL COLORS

POWDER COAT PAINTED STEEL FRAMES AND ACCESSORIES

Pro-Line Standards

LIGHT BEIGE LIGHT BLUE LIGHT GRAY

F63H11

F63L14

F63A31

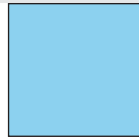
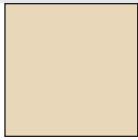

All Other Colors are Available at an Additional Charge

Textured White RFW627

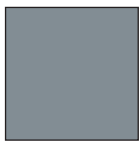

Dark Gray
F63A13



Dark Blue
F63L16



Gloss Black
F63B12

Standard DIMENSION NEXT COLORS



Textured
Black
505T2



Textured
Beige
530T2

Modular Cabinet Housings-Textured



Standard
Soft Blue
607T3

Also available in these colors
at an upcharge, Gray PLH606
White RFW627 & Black 505T2

Standard FOR BASICS MODEL



Textured
Black
505T2



Dark Blue
F63L16

ESD PAINT



Available
*Call for pricing

WORK SURFACE COLORS

PLASTIC LAMINATE TOP COLORS

Pro-Line Standard
WHITE SW806



*Other Colors Available at an Additional charge



*Black
SE101



*Royal Blue
SB009



*Beige
ST617



*French
Blue
SB005



*Mercury
(Lt.Gray)
SG204

ESD PLASTIC LAMINATE

Pro-Line Standard
WHITE SW837



For stainless steel, perforated, chemical resistant
lab tops or any other tops please consult factory.

*Other Colors Available at an Additional charge



*Beige
S-2-64



*Light Blue
S-3-35



*Dove Gray
SG248

WORK SURFACE T-MOLD EDGES

Pro-Line Standard
BLACK



*Other Colors Available at an Additional charge



*Brown



*White



*Gray

Self Edged Tops Available at an Additional charge per Edge

ROHS COMPLIANT

Identify an area as "Lead Free"
Have your painted steel, frames
and accessories painted green
at no extra charge Part# PGS8



SEATING COLOR OPTIONS

See Pages 44 and 45
for Seating

Standard Fabrics and Vinyls

Standard Fabrics

1 Burgundy	2 Medium Blue	3 Royal Blue	4 Navy Blue	5 Beige	6 Green	7 Gray	8 Black
---------------	------------------	-----------------	----------------	------------	------------	-----------	------------

Standard Vinyls

15 Black	16 Royal Blue
-------------	------------------



All models come with Chrome Frame
and Polished Aluminum Base

11 Slate Blue	12 Navy Blue	13 Gray	14 Charcoal
------------------	-----------------	------------	----------------

Static Control Fabric

Note: Due to printing limitations, color on this page may vary slightly
from actual color. Please consult with your Pro-line representative to
see actual paint, laminate or fabric samples if color is critical.



A Division of R. W. Hatfield Co., Inc.
10 AVCO ROAD, HAVERHILL, MA 01835



“PCP” Series

Pedestal Station
Featuring Heavy Duty 16 gauge
Steel Modular Cabinets

Phone: 978-521-2600 FAX: 978-374-4885
TOLL FREE: 1-800-739-9067

THE LEADING EDGE IN MODULAR ERGONOMICS



Model CPB

Packaging Workstations **IN STOCK**



RETRACTABLE “POP UP” BALL TRANSFER
TABLES, CARTS, LIFTS

Various Ball Patterns Available.
Eliminates Lifting in Your Facility.



Model MRBT

Lifting Heavy Products On and Off Transport
Carts? Eliminate Potential Back Injury with
Mobile “Pop Up” Ball Carts!



Pro-Lab Series

Modular Laboratory Furniture
Our Pro-lab series enables you to easily
configure your lab to meet your specific needs

- Workstations
- Lab Furniture
- Modular Cabinets
- Shelving
- Seating
- L.A.N. Stations
- Pack Stations
- Ball Transfers



Model MVSII

The MILLENNIUM II Electric Vertical Adjust Workstation
at the push of a button. **IN STOCK**
“The Industrial Workstation for the Next Millennium”

www.1proline.com
www.Industrialworkbenches.com